



Prices effective February 5, 2018

Published June 2018

Meridian® Lateral Files

Introduction	page 2
Meridian® Lateral Files	3
Stackable™ Lateral Files (Spec-A-File)	5
Freestanding Stackable Lateral Files (Standard Configuration)	25
Standard Pull	25
Arc Pull	30
Bar Pull	36
Bevel Pull	42
Ellipse Pull	47
Sloped Pull	53
Stackable Lateral File Cushion Tops	59
Mobile Stackable Lateral Files	61
Standard Pull	61
Bevel Pull	66
Low Credenza	71
File Tops	76
File Surrounds	80
Stackable Lateral File Accessories	89
Keyless Locks	95
Indices	99
By Name	99
By Number	101
Appendices	
20-Day or Less/Assigned Lead-Time Order Information	
Keyed-Alike Information	
Vary Easy Program	
Stain-to-Match Program	
Customer's Own Material/Customer's Own Leather Order Information-Cushion Tops	
Proprietary Textiles Application Chart-Seating	
Proprietary Textile Colors-Seating	
Maharam® Application Chart-Seating	
Maharam Colors-Seating	
For the latest materials information, refer to the Materials pages on HermanMiller.com.	

Introduction

A Note on the Organization of This Book

There are a few signals that will help you understand the organization of this book. Once you know them, you should be able to find your way around easily.

Like a newspaper, this book is formatted with columns of text and illustrations that run vertically.

Information wraps from one column to the next and continues for as many pages as it needs to.

Black bars are clues.

A black bar at the top of a page signals the start of information about a product.

This information is divided into two sections, each signaled by a black bar. Product Information includes a description, additional notes, and dimensional drawings. Specification Information, which always begins at the top of a column, includes a series of steps. Each step represents a decision you need to make in order to complete your product number. Steps must be followed sequentially. The number of pages needed to complete information on a product varies; some will be complete in one page; others may fill three or four pages. Just continue going through the steps until you run into the next product, signaled by the black bar at the top of the page.

Black tabs running along the outside edge of the page help you locate what section you are in or what section you want to go to. You can thumb forwards or backwards to find a section; tabs and text appear on both sides of the page.

The additional pages in the back of the book include the appendices and indices. They are signaled by a long black bar running along the outside edge of the page.

The index is presented two ways.

The first index is in alphabetical order by product name. It can be helpful if you are new to the products and numbering scheme or if you are looking for a type of product, such as work chair or round table.

The second index is by product number. It lists, in alphanumeric order, the base product number, typically a five-digit number.

General Information

This book is effective February 5, 2018, subject to change without notice. Products may be purchased from authorized Herman Miller dealers who will quote prices upon request. For more information about our products and services or to see a list of dealers, visit www.HermanMiller.com.

All prices are list prices. Additional services, such as planning services, design, storage, and installation, are not included and must be added to these prices when the additional services are requested.

Illustrations, specifications, and prices are based on the latest information at the time of publication. The right is reserved to make changes at any time without notice in prices, fabrics, finishes, materials, specifications, and models, and also to discontinue models and finishes.

Dimensions shown in the drawings are engineering drawing dimensions rounded up to the nearest $\frac{1}{8}$ ". Product is shipped set up or knocked down. Products that include "Shipped knocked down" in the description require some assembly. If this statement does not appear in the description, the product is shipped assembled.

Service problems are normally handled by a Herman Miller authorized dealer. Where this cannot be accomplished on a local level, service problems should be referred to the Customer Care Representative for your region, Herman Miller, Inc., Zeeland, Michigan 49464.

20-Day or Less/Assigned Lead-Time Shipments

All products and options in this price book not designated by an Assigned Program icon  will ship in **20 business days or less** after being acknowledged by Herman Miller.

Products and options designated by an  are on the assigned lead-time program and may ship in 20 days, less than 20 days, or more than 20 days from order acknowledgement.

Stackable™ Lateral Files (Spec-A-File)

Meridian® Stackable™ Lateral Files

Drawer Capacity & 20" Depth Filing

Drawer Capacity	Module Type	Case Depth	30" Letter	30" Legal	36" Letter	36" Legal	42" Letter	42" Legal
	Side-to-Side Filing in: C, D, N, E, G, H, L & P modules	20" or 18"	26 1/2"	26 1/2"	32 1/2"	32 1/2"	38 1/2"	38 1/2"
	Front-to-Back Filing in: N, P, E & D modules	20" 18"	35 1/2" 31 1/2"	N/A N/A	41 1/2" 37 1/2"	35 1/2" 31 1/2"	53 1/4" 47 1/4"	35 1/2" 31 1/2"

Filing Comparison

42" Wide Drawers

Side-to-Side Letter or Legal
38 1/2 Filing Inches

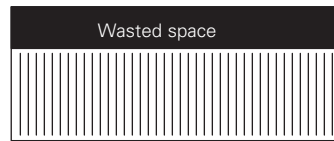

Front-to-Back Letter
53 1/4 Filing Inches

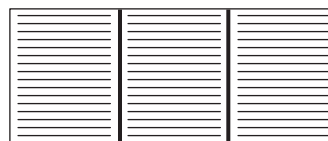

Note: 38% more filing capacity than side-to-side filing.

36" Wide Drawers

Side-to-Side Letter or Legal
32 1/2 Filing Inches

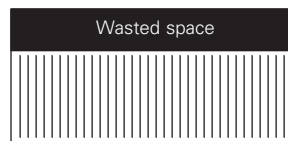

Front-to-Back Letter
41 1/2 Filing Inches

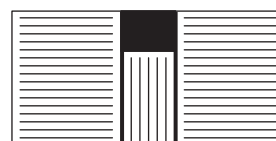

Note: 28% more filing capacity than side-to-side letter type.

Front-to-Back Legal
35 1/2 Filing Inches

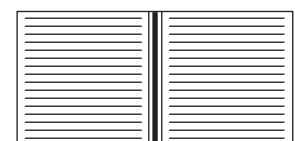

Note: 9% more filing capacity than side-to-side legal type.

30" Wide Drawers

Side-to-Side Letter or Legal
26 1/2 Filing Inches

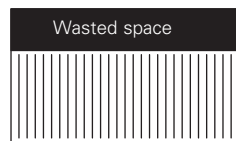

Front-to-Back Letter
35 1/2 Filing Inches

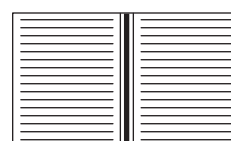

Note: 34% more filing capacity than side-to-side letter type.

Meridian® Stackable™ Lateral Files

General Information

Standard Pull (26)

Bar Pull (2KP)

Bevel Pull (24)

Spec-A-File

General Information

General Information

The Spec-A-File ordering procedure was designed to aid specifiers in meeting their exact filing needs. Since each component of the file (top, module, interior, base) is chosen individually, each file is a unique storage solution. The variety of top, module, and base heights available make the concern of meeting critical vertical heights a thing of the past.

Spec-A-File is comprised of the following four components. Each component must be clearly specified and priced separately.

Note: Metallic paints have an upcharge of \$65 when specified for the case, and \$10 when specified for the leg base.



Tops

Four heights are available (1/32", 1", 1 1/4", 6 1/2") in finishes of baked enamel. Laminate and veneer tops are available in 1 1/4" only. Veneer tops with oversail edge are 1 1/8".

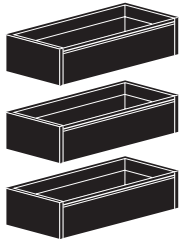

Modules

Various modules are available in heights of 11 3/4", 13 1/8", 15 1/8", 17 5/8", and 26 1/4".

Interiors

Several interior options are provided to meet your filing needs.



Bases

Five heights are available (1", 1 1/2", 2 1/4", 3 1/4", 4 1/4") in finishes of baked enamel.

Locks

Flush locks.



Final Assembly

Meridian will assemble all components as a complete lateral file up to 78". Files taller than 78" will be shipped as two units for final field assembly. Instructions are included.

Meridian® Stackable™ Lateral Files

Advanced Options

Spec-A-File



Add-On Modules

In order to accommodate additional filing needs, add-on modules are available for field installation to an existing lateral file. Modules do not have a base and can be ordered with or without a top. If a lock cylinder is needed, see lock appendix for ordering information. If the lock cylinder resides in the existing file, the add-on modules will need to be specified with lockbars.

Example: 26-3618-ADDON

Lock Option: LB-Lockbars, to attach to an existing unit



Reversed Modules

Reversed file drawers allow one stack of lateral file modules to service two users—conserving floor space. For safety reasons, only one direction reversal is allowed per file. The number of modules facing each direction is not limited.

Drawers are reversed in the field by utilizing a stile lock hardware kit for additional lock and a reversing conversion kit for additional inter-lock pieces. Kit number: U1B31V4

Factory-reversed units need to be ordered through Herman Miller Options.

Advanced Options

The flexibility and modularity of the stackable lateral file modules allow a specifier to create an infinite number of storage solutions.

To further enhance the uniqueness of the file, use one of the following advanced options available in Advanced Spec-A-File:

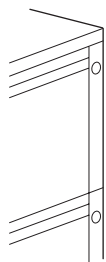

Multiple Locks – Standard Pull

Since the lock is housed in the module frame of standard pull lateral files, locks can be strategically placed to accommodate multiple users in one filing unit. In the case of keyed alike, identified modules will have factory-installed lockbars and lock hole knocked out to allow for field installation of lock cylinder. If additional security is required between drawers, specify security pans between modules.

Existing files can be retrofitted with multiple locks by requesting a stile lock hardware kit from your Customer Care representative.



Combination Lateral File

It is considered to be a combination lateral file when combining standard pull with bevel or contour pull lateral file drawers. To specify a combination unit, choose a bevel or contour pull lateral file in Advanced Spec-A-File. The standard pull modules will be listed on the module choices, signified by the following note (2600 Series).

Multiple Paints

Multiple paints are available on a single unit by specifying one of the following options:

- F: Different case and front finishes
- M: Different top, module, and base finishes
- N: Unit all one color







Meridian® Stackable™ Lateral File Tops

Standard Pull (26)

Bar Pull (2KP)

Bevel Pull (24)

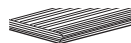
Spec-A-File

Tops	Description	Spec Code	H	D	W	LIST PRICE		
No Top		NT				N/C		
 Square Edge Metal Top	Metal top with square edge. Baked enamel finish.	T1	1"	20" or 18"	30"	\$ 65.		
					36"	\$ 81.		
					42"	\$ 96.		
		T2	1 1/4"	20" or 18"	30"	\$ 65.		
					36"	\$ 81.		
					42"	\$ 96.		
 Radius Edge Metal Top	Metal top with radius edge front and back. Baked enamel finish.	T3	1 1/4"	20" or 18"	30"	\$ 129.		
					36"	\$ 144.		
					42"	\$ 161.		
		 Laminate Top with Vinyl Edge*	Laminate top with vinyl edge.	TL	1 1/4"	20" or 18"	30"	\$ 138.
							36"	\$ 153.
							42"	\$ 170.
 Wood Veneer Top	Wood veneer top with 3mm edge banding.	TF A	1 1/4"	20" or 18"	30"	\$ 223.		
					36"	\$ 239.		
					42"	\$ 257.		
 Recut Veneer Top	Recut veneer top with 3mm edge banding.	TR A	1 1/4"	20" or 18"	30"	\$ 217.		
					36"	\$ 233.		
					42"	\$ 250.		
 Wood Veneer Top with Oversail Front Edge*	Wood veneer top and wood composite edge with oversail front.	TV1 A	1 1/8"	20" or 18"	30"	\$ 393.		
					36"	\$ 408.		
					42"	\$ 426.		
 Security Top	Flat steel cover with baked enamel finish. Designed to protect contents and minimize overall height; not to be used for support or as an exposed top. Available on N, E and H modules and Overhead Storage Units only.	T6	1/32"	20" or 18"	30"	\$ 65.		
					36"	\$ 81.		
					42"	\$ 96.		
					Note: Not field installable on Overhead Storage Units.			
 Planter Top*	Steel shell with baked enamel finish. Includes black plastic tub liner. Cannot house a lock.	T7	6 1/2"	20" or 18"	30"	\$ 270.		
					36"	\$ 284.		
					42"	\$ 302.		
					* Note: When ordering a radius edge laminate top, laminate top with vinyl edge banding, planter top with a bevel pull product, or a veneer top with oversail edge, an additional top is required if the file is to include a lock. Call Customer Service for details.			



Meridian® Stackable™ Lateral File Dome Tops

Standard Pull (26)

Bar Pull (2KP)

Bevel Pull (24)

Spec-A-File

Tops	Description	Spec Code	H	D	W	LIST PRICE
Full Dome Top 	6 1/2" high metal top with full dome side-to-side. Baked enamel finish.	D1	6 1/2"	18" or 20"	30"	\$ 344.
					36"	\$ 361.
					42"	\$ 377.
Half Dome Top 	6 1/2" high metal top with half dome sloping left. Baked enamel finish.	H1	6 1/2"	18" or 20"	30"	\$ 344.
					36"	\$ 361.
					42"	\$ 377.
	6 1/2" high metal top with half dome sloping right. Baked enamel finish.	H2	6 1/2"	18" or 20"	30"	\$ 344.
					36"	\$ 361.
					42"	\$ 377.

Note: When specifying a half dome or full dome top with bevel or bar pull lateral files, a lock option is not available.

Meridian® Stackable™ Lateral File Cushion Tops/Cushion Fabrics

Standard Pull (26)

Bar Pull (2KP)

Bevel Pull (24)

Spec-A-File

Tops	Description	Spec Code	H	D	W	LIST PRICE
	Cushion top available 1" or 2" high, provides temporary guest seating. Attaches with velcro strips to 1" metal top included.	TC1	1"	18" or 20"	30"	\$ 398.
		TC2	2"		36"	\$ 398.
					42"	\$ 399.

Tops	Description	Spec Code	Fabric Category	UPCHARGE
	Cushion available in Herman Miller seating fabric. Fabric requirements: Customer's Own Material (COM) requires yardage listed below.	See textile appendices for fabric families and color codes.	Price Category 1	N/C
			Price Category 2	\$ 68.
			Price Category 3	\$ 82.
			Price Category 4	\$ 101.
			Price Category 5	\$ 120.
			Price Category 7	\$ 137.
			Price Category 9	\$ 950.
			Price Category B	\$ 47.
			Price Category C	\$ 65.
			Price Category D	\$ 82.
			Price Category E	\$ 99.
			Price Category F	\$ 141.
			Price Category G	\$ 166.
Price Category H	\$ 204.			
Price Category I	\$ 264.			
Price Category J	\$ 276.			

Width of Cushion	Yards of Fabric
30"	1.05
36"	1.22
42"	1.40

When ordering more than one cushion, please round up the total yardage requirement to the next full yard of fabric.

Meridian® Stackable™ Lateral File Overhead Storage Units

Standard Pull (26)
Bar Pull (2KP)
Bevel Pull (24)

Spec-A-File



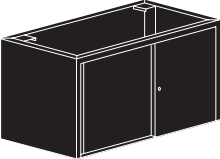
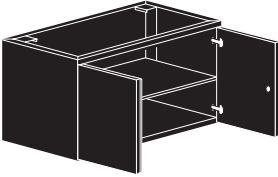
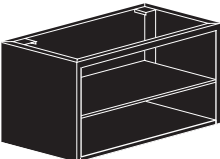

Description		Spec Code	H	D	W	Standard Pull (26)	Bar Pull (2KP)	Bevel Pull (24)
26 1/4" High								
OS 	Overhead Storage*. Cabinet with locking sliding doors. Includes one adjustable shelf. (KA) lock options not available. Interior depth: 18" (20") and 16" (18"). Interior height: 24 1/4".	OS	26 1/4"	20"	30"	\$ 545.	N/A	N/A
					36"	\$ 622.	N/A	N/A
					42"	\$ 699.	N/A	N/A
					18" 30"	\$ 545.	N/A	N/A
					36"	\$ 622.	N/A	N/A
					42"	\$ 699.	N/A	N/A
OH 	Overhead Storage*. Cabinet with locking hinged doors. Includes one adjustable shelf. Interior depth: 18" (20") and 16" (18"). Interior height: 24 1/4".	OH	26 1/4"	20"	30"	\$ 593.	\$ 618.	\$ 581.
					36"	\$ 666.	\$ 693.	\$ 652.
					42"	\$ 746.	\$ 777.	\$ 731.
					18" 30"	\$ 593.	\$ 618.	\$ 581.
					36"	\$ 666.	\$ 693.	\$ 652.
					42"	\$ 746.	\$ 777.	\$ 731.
OB 	Overhead Storage*. Cabinet without doors. Includes one adjustable shelf. Interior depth: 18" (20") and 16" (18"). Interior height: 24 1/4".	OB	26 1/4"	20"	30"	\$ 501.	\$ 501.	N/A
					36"	\$ 581.	\$ 581.	N/A
					42"	\$ 654.	\$ 654.	N/A
					18" 30"	\$ 501.	\$ 501.	N/A
					36"	\$ 581.	\$ 581.	N/A
					42"	\$ 654.	\$ 654.	N/A
Note: *When ordering an overhead storage with a bevel pull lateral file, an additional top is required if the file drawers are to lock. Call Customer Service for details.								
Application Notes: *Other modules can be placed on top of an overhead storage unit only if they have a fixed shelf. Pull out shelves may not be used above an overhead storage unit.								
Note: Doors and drawers will be proud of this module.								

Meridian® Stackable™ Lateral File Overhead Storage Units – Multi-User Standard Pull (26)

Spec-A-File

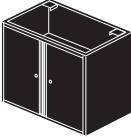

Tops	Description	Spec Code	H	D	W	Standard Pull (26)	LIST PRICE
OI 	23 ¹ / ₂ " partitioned overhead storage unit with two individually locking hinged doors and one adjustable shelf per opening. Interior depth: 18" (20") and 16" (18"). Interior height: 21 ¹ / ₂ ".	OI	23 ¹ / ₂ "	20"	30"		\$ 915.
					36"		\$ 988.
					42"		\$ 1059.
					18"	30"	\$ 915.
					36"	\$ 988.	
					42"	\$ 1059.	
OM 	26 ¹ / ₄ " partitioned overhead storage unit with two individually locking hinged doors and one adjustable shelf per opening. Interior depth: 18" (20") and 16" (18"). Interior height: 24 ¹ / ₄ ".	OM	26 ¹ / ₄ "	20"	30"		\$ 945.
					36"		\$ 1015.
					42"		\$ 1088.
					18"	30"	\$ 945.
					36"	\$ 1015.	
					42"	\$ 1088.	

The OI and OM overhead storage units can be used in conjunction with individually locking standard pull drawer modules to create multi-user storage and filing units. Security pans between drawers are available. Modules can also be reversed. The following examples can be used as guidelines, or contact your Customer Care representative for more details on reversed module stack combinations.

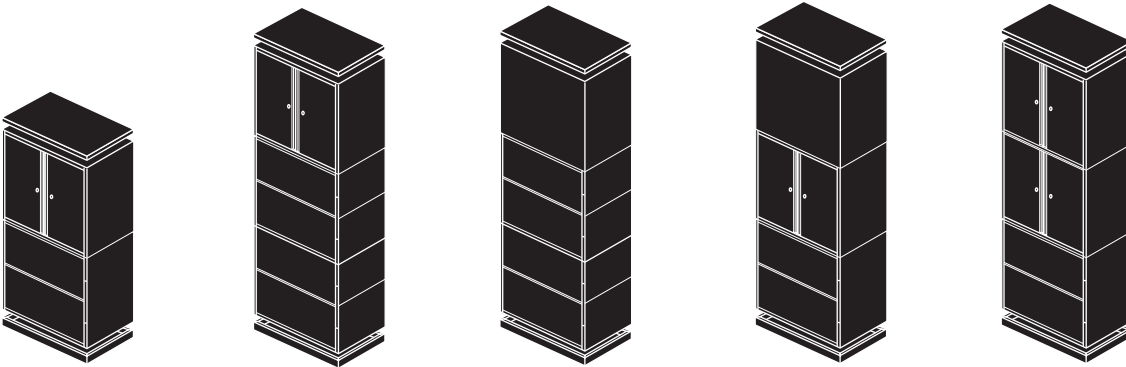

Additional Storage Shelf	Description	Spec Code	Cabinet	D	W	LIST PRICE
	Adjustable steel shelf with baked enamel finish. 15" fits one opening of 30" wide partitioned cabinet. 18" fits one opening of 36" wide partitioned cabinet. 21" fits one opening of 42" wide partitioned cabinet.	SSF-15				\$ 57.
		SSF-18				\$ 63.
		SSF-21				\$ 68.

Meridian® Stackable™ Lateral File Modules

Standard Pull (26)

Bar Pull (2KP)

Bevel Pull (24)

Spec-A-File

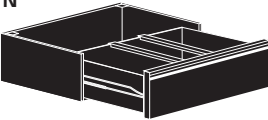
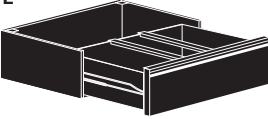
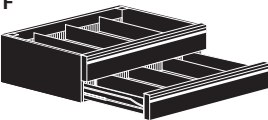
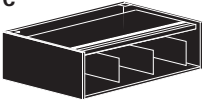
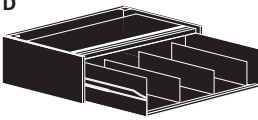

Modules	Description	Spec Code	H	D	W	Standard Pull (26)	Bar Pull (2KP)	Bevel Pull (24)
11³/₄" High								
LIST PRICE								
N 	File drawer / fixed front. Standard 9P interior: hanging folder rails for front-to-back filing. Optional interiors: 9M, 9R, 9W-LT, 9W-LG, 9C-LT, 9C-LG. Interior depth: 17 ³ / ₄ " (20") or 15 ³ / ₄ " (18"). Interior height: 10 ⁵ / ₈ ". Hanging clearance: 97/ ₁₆ " for 9P, 9R, 9C-LG, 9C-LT.	N	11 ³ / ₄ "	20" or 18"	30"	\$ 324.	\$ 337.	\$ 324.
					36"	\$ 353.	\$ 368.	\$ 353.
					42"	\$ 397.	\$ 417.	\$ 397.
13¹/₈" High								
E 	File drawer / fixed front. Standard 9P interior: hanging folder rails for front-to-back filing. Optional interiors: 9M, 9R, 9W-LT, 9W-LG, 9C-LT, 9C-LG. Interior depth: 17 ³ / ₄ " (20") or 15 ³ / ₄ " (18"). Interior height: 12". Hanging clearance: 97/ ₁₆ " for 9P, 9R, 9C-LG, 9C-LT.	E	13 ¹ / ₈ "	20" or 18"	30"	\$ 324.	\$ 337.	\$ 324.
					36"	\$ 353.	\$ 368.	\$ 353.
					42"	\$ 397.	\$ 417.	\$ 397.
F 	Two half height drawers with fixed fronts. Standard 9T interior: 3 adjustable partitions per half drawer for index card filing. Interior depth: 17 ³ / ₄ " (20") or 15 ³ / ₄ " (18"). Interior height: 5 ³ / ₈ ".	F	13 ¹ / ₈ "	20" or 18"	30"	\$ 624.	\$ 649.	\$ 624.
					36"	\$ 653.	\$ 680.	\$ 653.
					42"	\$ 697.	\$ 726.	\$ 697.
C 	Fixed shelf / flip door. Standard 9M interior: 3 movable dividers for side-to-side paper folder filing. Optional interiors: 9V. Interior depth: 17 ³ / ₄ " (20") or 15 ³ / ₄ " (18"). Interior height: 10 ¹ / ₄ ".	C	13 ¹ / ₈ "	20" or 18"	30"	\$ 328.	N/A	N/A
					36"	\$ 361.	N/A	N/A
					42"	\$ 405.	N/A	N/A
D 	Pull-out shelf / flip door. Standard 9M interior: 3 movable dividers for side-to-side paper folder filing. Optional interiors: 9Q, 9R, 9V, 9W-LT, 9W-LG, 9C-LT, 9C-LG. Interior depth: 17 ³ / ₄ " (20") or 15 ³ / ₄ " (18"). Interior height: 10 ¹ / ₄ ". Hanging clearance: 97/ ₁₆ " for 9P, 9R, 9C-LG, 9C-LT.	D	13 ¹ / ₈ "	20" or 18"	30"	\$ 369.	N/A	N/A
					36"	\$ 397.	N/A	N/A
					42"	\$ 440.	N/A	N/A

Meridian® Stackable™ Lateral File Modules – *Continued*



Standard Pull (26)

Bar Pull (2KP)

Bevel Pull (24)

Spec-A-File



Modules	Description	Spec Code	H	D	W	Standard Pull (26)	Bar Pull (2KP)	Bevel Pull (24)
13¹/₈" High								
						LIST PRICE		
J 	Open module with full back accommodates binders up to 11 ³ / ₄ " tall. Interior depth 17 ¹ / ₂ " or 19 ¹ / ₂ ". Interior height: 11 ⁷ / ₈ ". Accommodates 9Y interiors (sold separately). Note: Cannot be used as the bottom module if a counterbalance is specified. Note: Security top cannot be attached to a "J" module. Note: Door and drawers will be proud of this module when using bar pull.	J	13¹/₈"	20" or 18"	30"	\$ 408.	\$ 408.	N/A
					36"	\$ 432.	\$ 432.	N/A
					42"	\$ 459.	\$ 459.	N/A
K 	Pass through unit. Interior depth: 19 ³ / ₄ " (20") or 17 ³ / ₄ " (18"). Interior height: 11 ⁷ / ₈ ". Note: Not field installable. Note: Door and drawers will be proud of this module when using bar pull.	K	13¹/₈"	20" or 18"	30"	\$ 334.	\$ 334.	N/A
					36"	\$ 361.	\$ 361.	N/A
					42"	\$ 407.	\$ 407.	N/A
P 	Combination posting shelf and 11 ³ / ₄ " fixed front file pullout drawer. Standard 9P interior: hanging folder rails for front-to-back filing. Optional interiors: 9M, 9R, 9W-LT, 9W-LG, 9C-LT, 9C-LG. Interior depth: 17 ³ / ₄ " (20") or 15 ³ / ₄ " (18"). Interior height: 10 ⁵ / ₈ ". Hanging clearance: 9 ⁷ / ₁₆ " for 9P, 9R, 9C-LG, 9C-LT.	P	13¹/₈"	20" or 18"	30"	\$ 453.	N/A	N/A
					36"	\$ 486.	N/A	N/A
					42"	\$ 528.	N/A	N/A

Meridian® Stackable™ Lateral File Modules – *Continued*



Standard Pull (26)

Bar Pull (2KP)

Bevel Pull (24)

Spec-A-File

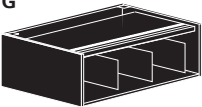
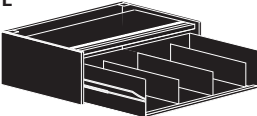
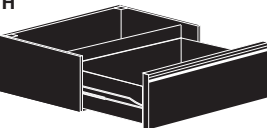

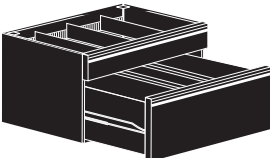
Modules	Description	Spec Code	H	D	W	Standard Pull (26)	Bar Pull (2KP)	Bevel Pull (24)
						LIST PRICE		
15 1/8" High								
G 	Fixed shelf / flip door. Standard 9M interior: 3 movable dividers for large folders and binder storage. Optional interiors: 9V. Interior depth: 17 3/4" (20") or 15 3/4" (18"). Interior height: 12 1/4". Note: Drawer front does not completely recede on 18" deep modules.	G	15 1/8"	20" or 18"	30"	\$ 466.	N/A	N/A
					36"	\$ 500.	N/A	N/A
					42"	\$ 539.	N/A	N/A
L 	Pullout shelf / flip door. Standard 9M interior: 3 movable dividers for large folders and binder storage. Optional interiors: 9V, 9W-LT, 9W-LG, 9X, 9Q. Interior depth: 17 3/4" (20") or 15 3/4" (18"). Interior height: 12 1/4". Hanging clearance: 9 9/16" for 9V, 11 9/16" for 9X. Note: Drawer front does not completely recede on 18" deep modules.	L	15 1/8"	20" or 18"	30"	\$ 513.	N/A	N/A
					36"	\$ 539.	N/A	N/A
					42"	\$ 589.	N/A	N/A
H 	File drawer / fixed front. Standard 9X interior: 2 rails for computer printout hanging binders and folders. Optional interiors: 9M, 9W-LT, 9W-LG, 9Q. To accommodate letter-width computer printout hanging binders, contact Meridian. Interior depth: 17 3/4" (20") or 15 3/4" (18"). Interior height: 14". Hanging clearance: 11 9/16" for 9X.	H	15 1/8"	20" or 18"	30"	\$ 426.	\$ 443.	\$ 426.
					36"	\$ 449.	\$ 469.	\$ 449.
					42"	\$ 495.	\$ 515.	\$ 495.
S 	Fixed shelf / locking sliding doors. Ideal for binder storage. Interior depth: 18" (20") or 16" (18"). Interior height: 13 1/8". (KA) lock options not available.	S	15 1/8"	20" or 18"	30"	\$ 413.	N/A	N/A
					36"	\$ 442.	N/A	N/A
					42"	\$ 492.	N/A	N/A
X 	Two drawers with 1 half high and 1 file drawer. Interiors available: 9P, 9M, 9R, 9W-LT, 9W-LG, 9C-LT, 9C-LG, for file drawer only. Interior file drawer depth: 17 3/4" (20") or 15 3/4" (18"). Interior height: 10 5/8". Hanging clearance: 9 7/16" for 9P, 9R, 9C-LG, and 9C-LT 15 3/4" (18"). Interior height: 10 5/8".	X	17 5/8"	20" or 18"	30"	N/A	\$ 862.	N/A
					36"	N/A	\$ 944.	N/A
					42"	N/A	\$ 1043.	N/A

Meridian® Stackable™ Lateral File Modules – *Continued*

Standard Pull (26)

Bevel Pull (24)

Spec-A-File

CD Storage*

Drawer Size	Number of CDs per Row	Number of Complete Rows per Half Drawer
30" x 18"	40	4
30" x 20"	44	4
36" x 18"	40	5
36" x 20"	44	5
42" x 18"	40	6
42" x 20"	44	6



*Calculation based on average CD size of $5\frac{5}{8}$ " x $4\frac{7}{8}$ " x $\frac{3}{8}$ ".

VHS Storage**

Drawer Size	Number of VHS Tapes per Row	Number of Complete Rows per Half Drawer
30" x 18"	12	3
30" x 20"	14	3
36" x 18"	12	4
36" x 20"	14	4
42" x 18"	12	4
42" x 20"	14	4



**Calculation based on average VHS case size of 8" x $4\frac{3}{4}$ " x $1\frac{1}{4}$ ".











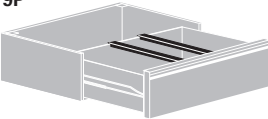

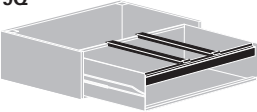

Meridian® Stackable™ Lateral Files

Interiors/Bases/Options

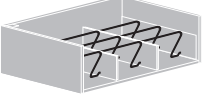
Standard Pull (26)
 Bar Pull (2KP)
 Bevel Pull (24)

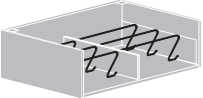
Spec-A-File

Note: Interiors 9P, 9Q, 9C-LG, 9C-LT, 9M and 9R for file drawer only in X module.

Interiors	Description	Filing Devices	Spec Code																
Front-To-Back Filing				U P C H A R G E															
9P 	Front-to-back filing rails for hanging file folders. Standard in modules: E, N, P, X.	 Hanging File Folder	9P	N/C															
9Q 	Front-to-back filing rails for hanging file folders. For use in flip door units. Optional in D, L and H modules.	 Hanging File Folder	9Q	N/C															
9C-LG 	Combination front-to-back and side-to-side rails for filing one row side-to-side legal and one row front-to-back letter of hanging file folders. Optional in modules E, N, D, P, X.	 Hanging File Folder	9C-LG	N/C															
9C-LT 	Combination front-to-back and side-to-side rails for filing one row side-to-side letter and one row front-to-back legal of hanging file folders. Optional in modules E, N, D, P, X.	 Hanging File Folder	9C-LT	N/C															
9W-LT 	Wobble dividers for filing letter size paper folders front-to-back. Optional in modules N, E, D, P, L, H.	  File Folder Expandable Pocket Folder	9W-LT	<table border="1"> <tr> <td>30" wide</td> <td style="text-align: right;">\$ 50.</td> </tr> <tr> <td>36" wide</td> <td style="text-align: right;">\$ 50.</td> </tr> <tr> <td>42" wide</td> <td style="text-align: right;">\$ 57.</td> </tr> </table>	30" wide	\$ 50.	36" wide	\$ 50.	42" wide	\$ 57.									
30" wide	\$ 50.																		
36" wide	\$ 50.																		
42" wide	\$ 57.																		
	<table border="1"> <thead> <tr> <th colspan="3">Letter</th> </tr> <tr> <th>File Width</th> <th>9M Dividers</th> <th>Letter Width Wobbles</th> </tr> </thead> <tbody> <tr> <td>30"</td> <td>4</td> <td>6</td> </tr> <tr> <td>36"</td> <td>4</td> <td>6</td> </tr> <tr> <td>42"</td> <td>6</td> <td>9</td> </tr> </tbody> </table>	Letter			File Width	9M Dividers	Letter Width Wobbles	30"	4	6	36"	4	6	42"	6	9			
Letter																			
File Width	9M Dividers	Letter Width Wobbles																	
30"	4	6																	
36"	4	6																	
42"	6	9																	
9W-LG 	Wobble dividers for filing legal size paper folders front-to-back. Optional in modules N, E, D, P, L, H.	 File Folder	9W-LG	<table border="1"> <tr> <td>30" wide</td> <td style="text-align: right;">\$ 50.</td> </tr> <tr> <td>36" wide</td> <td style="text-align: right;">\$ 57.</td> </tr> <tr> <td>42" wide</td> <td style="text-align: right;">\$ 57.</td> </tr> </table>	30" wide	\$ 50.	36" wide	\$ 57.	42" wide	\$ 57.									
30" wide	\$ 50.																		
36" wide	\$ 57.																		
42" wide	\$ 57.																		
	<table border="1"> <thead> <tr> <th colspan="3">Legal</th> </tr> <tr> <th>File Width</th> <th>9M Dividers</th> <th>Legal Width Wobbles</th> </tr> </thead> <tbody> <tr> <td>30"</td> <td>2</td> <td>3</td> </tr> <tr> <td>36"</td> <td>4</td> <td>6</td> </tr> <tr> <td>42"</td> <td>4</td> <td>6</td> </tr> </tbody> </table>	Legal			File Width	9M Dividers	Legal Width Wobbles	30"	2	3	36"	4	6	42"	4	6			
Legal																			
File Width	9M Dividers	Legal Width Wobbles																	
30"	2	3																	
36"	4	6																	
42"	4	6																	
9T 	Set of six movable partitions, 3 per half-height drawer. Standard in modules F only.		9T	N/C															
9Y 	Three movable magnetic dividers for large binder storage. Side-to-Side Filing only. 12" H X 5"W X 16"D		9Y	N/C															

Meridian® Stackable™ Lateral Files

Interiors/Bases/Options – *Continued*











Standard Pull (26)



Bar Pull (2KP)

Bevel Pull (24)

Spec-A-File

Note: Interiors 9P, 9Q, 9C-LG, 9C-LT, 9M and 9R for file drawer only in X module.

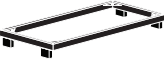
Interiors	Description	Filing Devices	Spec Code	
Side-To-Side Filing				U P C H A R G E
9M 	Three movable dividers for filing paper folders. Standard in modules: C, D, G, L. Optional in modules: E, N, H, P, X.	 File Folder  Binder  Expandable Pocket Folder	9M	N/C
9R 	Side-to-side rails for hanging file folders (letter, legal, A-4, foolscap). Optional in modules: E, N, D, H, P, X. 1 required for E, N, and P modules. 2 required for D and H modules.	 Hanging File Folder	9R	N/C
9V 	Movable dividers (9M) with side-to-side rail (9R) for tab style side-to-side filing. Optional in modules: C, D, G, L.	 File Folder	9V	N/C
9X 	Side-to-side filing rails for computer printout hanging binders and folders, 2 rails included. Standard in H module. Optional in L module.	 Standard Hanging Computer Paper Folder	9X	N/C

Bases / Options	Description	Spec Code	H	D	W	LIST PRICE	
Bases 	Frame-type steel base with baked enamel finish. Includes four adjustable leveling glides.	B1	1"	20" or 18"	30"	\$ 81.	
		B2	1 1/2"		36"	\$ 96.	
		B3	2 1/4"		42"	\$ 112.	
		B4	3 1/4"				
		B5	4 1/4"	20" or 18"	30"	\$ 118.	
Leg Bases with Legs 	Frame-type steel base with baked enamel finish. Includes four Canvas-style legs. Note: Legs must be field installed.		1 1/2"	20" or 18"	30"	\$ 243.	
					36"	\$ 260.	
					42"	\$ 274.	
Recessed Bases 	Frame-type steel base with baked enamel finish. Recessed 1 1/16". Includes four adjustable leveling glides.	BA	1"	20" or 18"	30"	\$ 118.	
		BB	1 1/2"		36"	\$ 135.	
		BC	2 1/4"		42"	\$ 149.	
		BD	3 1/4"				
Lock	Flush lock. Locks are located in the module frame in the standard pull lateral file. Locks are located in the top in the bevel pull lateral files.	KD, KC, or KA				\$ 38.	
Counterbalance Weight	Recommended for 2 and 3-high lateral files.	CB Add \$86 to Counterweight price for 1-high freestanding lateral modules N, E, D, P, L and H				\$ 127.	
Security Pan 	Flat steel pan placed between modules of a lateral file stack. For use on B, C, D, E, F, G, H, L, X, N, P modules. Available through Advanced Spec-A-File. Contact Customer Care for information	PN	1/32"	20" or 18"	30"	\$ 41.	
					36"	\$ 47.	
					42"	\$ 55.	

Note: List price upcharge is for quantity 1 security pan.

Meridian® Stackable™ Lateral Files Retrofit Interiors

The prices below are the retrofit prices for field installing these interiors in appropriate **existing** lateral file drawers. Option includes all parts and instructions. Be certain to specify the "part" number corresponding to the width and depth of file to be fitted.

Front-To-Back Filing				Side-To-Side Filing			
Description	Part Number	LIST PRICE		Description	Part Number	LIST PRICE	
9P	30" x 18"	9P0018	\$ 28.	9M ea	All 18"	9M10018	\$ 15.
9P	36" x 18"	9P3618	\$ 28.	9M ea	All 20"	9M10020	\$ 15.
9P	42" x 18"	9P0018	\$ 28.	9M set of 3	All 18"	9M30018	\$ 35.
9P	30" x 20"	9P0020	\$ 28.	9M set of 3	All 20"	9M30020	\$ 35.
9P	36" x 20"	9P3620	\$ 28.	9R ea	30" x 18/20"	9R13000	\$ 21.
9P	42" x 20"	9P0020	\$ 28.	9R ea	36" x 18/20"	9R13600	\$ 21.
9Q	30" x 18"	9Q3018	\$ 45.	9R ea	42" x 18/20"	9R14200	\$ 21.
9Q	36" x 18"	9Q3618	\$ 45.	9R set of 2	30" x 18/20"	9R23000	\$ 41.
9Q	42" x 18"	9Q4218	\$ 45.	9R set of 2	36" x 18/20"	9R23600	\$ 41.
9Q	30" x 20"	9Q3020	\$ 45.	9R set of 2	42" x 18/20"	9R24200	\$ 41.
9Q	36" x 20"	9Q3620	\$ 45.	9V	30" x 18"	9V3018	\$ 45.
9Q	42" x 20"	9Q4220	\$ 45.	9V	36" x 18"	9V3618	\$ 45.
9C-LT	30" x 18/20"	9C3000LT	\$ 45.	9V	42" x 18"	9V4218	\$ 45.
9C-LT	36" x 18/20"	9C3600LT	\$ 45.	9V	30" x 20"	9V3020	\$ 45.
9C-LT	42" x 18/20"	9C4200LT	\$ 45.	9V	36" x 20"	9V3620	\$ 45.
9C-LG	30" x 18/20"	9C3000LG	\$ 45.	9V	42" x 20"	9V4220	\$ 45.
9C-LG	36" x 18/20"	9C3600LG	\$ 45.	9X	30" x 18/20"	9X3000	\$ 39.
9C-LG	42" x 18/20"	9C4200LG	\$ 45.	9X	36" x 18/20"	9X3600	\$ 39.
9W-LT	30"/36" x 18"	9W0018LT	\$ 86.	9X	42" x 18/20"	9X4200	\$ 39.
9W-LT	42" x 18"	9W4218LT	\$ 94.	9Y ea	12"Hx5"Wx16"D	9Y10000	\$ 40.
9W-LT	30"/36" x 20"	9W0020LT	\$ 86.				
9W-LT	42" x 20"	9W4220LT	\$ 94.				
9W-LG	30" x 18"	9W3018LG	\$ 86.				
9W-LG	36"/42" x 18"	9W0018LG	\$ 94.				
9W-LG	30" x 20"	9W3020LG	\$ 86.				
9W-LG	36"/42" x 20"	9W0020LG	\$ 94.				
9T ea	All 18"	9T10018	\$ 15.				
9T ea	All 20"	9T10020	\$ 15.				
9T set of 6	All 18"	9T60018	\$ 61.				
9T set of 6	All 20"	9T60020	\$ 61.				

* Specify paint color

Meridian® Stackable™ Lateral Files Card Tray

Card Tray Interior

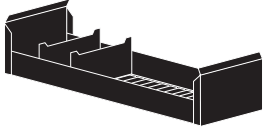

Description

Consists of removable card tray with 2 5¹/₂" dividers for card filing. To be used only with F modules. Partial bottom with open center.

Card Trays (all sizes)





LIST PRICE

\$ 59.

Card Tray Interiors

Actual Dimension	Card Size	File Depth	Item No.	Drawer Width	Trays Per Drawer
5 ³ / ₈ " w x 15 ³ / ₈ " d x 5 ¹ / ₄ " h	3 x 5	18"	CT-3518	30"	4
				36"	6
				42"	7
5 ³ / ₈ " w x 17 ³ / ₈ " d x 5 ¹ / ₄ " h		20"	CT-3520	30"	4
				36"	6
				42"	7
6 ³ / ₈ " w x 15 ³ / ₈ " d x 5 ¹ / ₄ " h	4 x 6	18"	CT-4618	30"	4
				36"	5
				42"	6
6 ³ / ₈ " w x 17 ³ / ₈ " d x 5 ¹ / ₄ " h		20"	CT-4620	30"	4
				36"	5
				42"	6
8 ³ / ₈ " w x 15 ³ / ₈ " d x 5 ¹ / ₄ " h	5 x 8	18"	CT-5818	30"	3
				36"	3
				42"	4
8 ³ / ₈ " w x 17 ³ / ₈ " d x 5 ¹ / ₄ " h		20"	CT-5820	30"	3
				36"	3
				42"	4
9 ³ / ₈ " w x 15 ³ / ₈ " d x 5 ¹ / ₄ " h	4 x 9	18"	CT-4918	30"	2
				36"	3
				42"	4
9 ³ / ₈ " w x 17 ³ / ₈ " d x 5 ¹ / ₄ " h		20"	CT-4920	30"	2
				36"	3
				42"	4

Meridian® Stackable™ Lateral Files Accessories

	Description	D	H	W	Item Number	Quantity	LIST PRICE
Movable Magnetic Divider 	Movable magnetic divider for storage of miscellaneous media. Side-to-side filing only. Available in black.	8"	9"		9Y10809	1	\$ 40.
		13"	12"		9Y11312	1	\$ 49.
		15"	9"		9Y11509	1	\$ 49.
File Drawer Organizer 	This two-sectioned organizer fits into any file drawer arranged for letter-size filing. The removable top section stores computer disks and other small items. The bottom section stores larger items or can be divided into 3 compartments; it includes 2 vertical dividers. Finish is black umber.	6"	9"	12"/s"	LG901.		\$ 79.
	Note: This organizer does not accept letter-size file folders.						
Multi-Media Index Divider 	Multi-media index dividers for a variety of media types including diskettes, CD-ROMs, microfiche, microfilm and index cards. Includes 2 9T front-to-back dividers and 4 index dividers.	18"	3"	3"	A128-030318		\$ 60.
		20"	3"	3"	A128-030320		\$ 60.
		18"	3"	5"	A128-030518		\$ 60.
		20"	3"	5"	A128-030520		\$ 60.
		18"	4"	6"	A128-040618		\$ 60.
		20"	4"	6"	A128-040620		\$ 60.
		18"	6"	5"	A128-060518		\$ 60.
20"	6"	5"	A128-060520		\$ 60.		
EnhancedAccess™ Pulls  Loop Style	These plastic loop-style pulls slide into the standard pulls on pedestal or lateral file drawers. They make the drawers easier to open. Package contains 1 pull and attachment hardware.	Loop Style			EAP-L		\$ 54.
	For use with standard pull modules only.						
	Available in: Black UMBER BU Inner Tone Light HF Medium Tone MT						

Freestanding Stackable™ Lateral Files

Mobile Stackable™ Lateral Files

Credenza Arc/Bar Pull

File Tops

File Surrounds

Stackable™ Lateral File Accessories

Keyless Locks



Standard-Pull Freestanding Lateral File

26-30
26-36
26-42

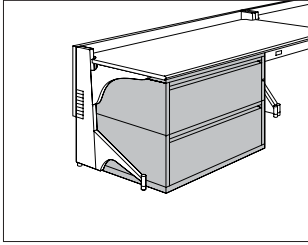

Product Information

Description

This lateral file holds letter-, legal-, and A4-size hanging files. It has standard pulls and smooth or textured steel. The file has no top or a metal, cushion, laminate, planter, or veneer top. A positive interlock system permits only 1 drawer to open at a time. 1 lock controls all drawers. The drawers can be specified with 3 dividers or with front-to-back or side-to-side filing rails for hanging files. The 5-high lateral file has 4 drawers and 1 flipper door; the flipper door includes a pullout shelf with 3 movable dividers. 5 base heights are available; all bases include adjustable glides.

Actual lateral file widths are 29⁷/₈" , 35⁷/₈" , or 41⁷/₈" ; actual depths are 17⁷/₈" or 19⁷/₈" .

Notes

For 2- or 3-high files that are not ganged or anchored, counterweights (option CB) are required. For 4- or 5-high files that are not ganged or anchored, counterweights are recommended.

When alternate drawer interior (9P, 9R, or 9M) is specified for 5-high lateral file, pullout shelf still includes 3 movable dividers.

For base height option (LB2), legs will be shipped separately.

For base height option (LB2), overall height is 3¹/₂" consisting of 1¹/₂" tube base with 2" legs.

Dimensional illustrations do not include all possible configurations.

To convert filing direction, order 1 of the following products separately:

- Front-to-back rail (9Pxxxx)
- Side-to-side rail (9Rxxxxx)

See Stackable Lateral File Accessories for specific product number.

Order optional file drawer organizer (LG901) separately.

For work surface on top of 1 or more lateral files, order file top (TPL or TPV) separately.

For cushion tops TC1 and TC2, a 1" metal top is included.

Cushion top accepts Customer's Own Material (COM). Yardage is estimated for nondirectional, 54"-wide fabrics. When ordering more than 1 cushion, round up total yardage requirement to next whole yard of fabric.

Width—Yardage

30" —1.05

36" —1.22

42" —1.40

For information on multiple quantities or directional fabrics, contact COM Department. See Order Information in Appendices.

For keyed-alike locks, order lock plugs separately. See Keyed-Alike Information in Appendices.

Dimensions

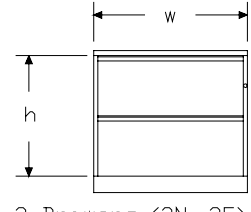
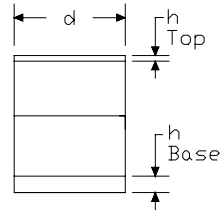

2 Drawers (2N, 2E)

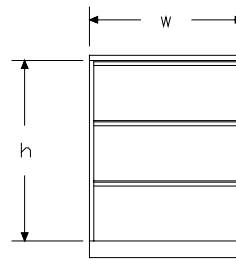

3 Drawers (3N, 3E)

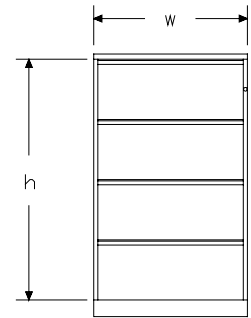

4 Drawers (4N, 4E)

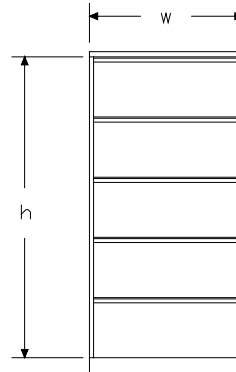

5 Drawers (5N)

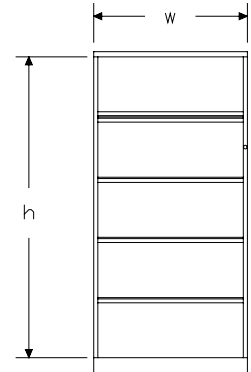

1 Flipper Door and 4 Drawers (5D, 5F)

h	N	E	D	F
2	23 1/2	26 1/4	-	-
3	35 1/4	39 3/8	-	-
4	47	52 1/2	-	-
5	58 3/4	-	60 1/8	65 5/8

All dimensions are in inches.

Standard-Pull Freestanding Lateral File *continued*

Specification Information	
Step 1.	
26-	
Step 2. Width	
30	30" wide
36	36" wide
42	42" wide
Step 3. Depth	
18-	18" deep
20-	20" deep
Step 4. Configuration	
2N	2 11 ³ / ₄ "-high drawers
3N	3 11 ³ / ₄ "-high drawers
4N	4 11 ³ / ₄ "-high drawers
5N	5 11 ³ / ₄ "-high drawers
5D	1 13 ¹ / ₈ "-high flipper door and 4 11 ³ / ₄ "-high drawers
2E	2 13 ¹ / ₈ "-high drawers
3E	3 13 ¹ / ₈ "-high drawers
4E	4 13 ¹ / ₈ "-high drawers
5F	1 13 ¹ / ₈ "-high flipper door and 4 13 ¹ / ₈ "-high drawers

Prices for Steps 1-4.							
		2N	3N	4N	5N	5D	2E
26-30	18-	\$819	1138	1459	1779	1825	819
	20-	\$819	1138	1459	1779	1825	819
26-36	18-	\$907	1257	1608	1958	2003	907
	20-	\$907	1257	1608	1958	2003	907
26-42	18-	\$1029	1422	1817	2214	2257	1029
	20-	\$1029	1422	1817	2214	2257	1029
				3E	4E	5F	
26-30	18-			\$1138	1459	1825	
	20-			\$1138	1459	1825	
26-36	18-			\$1257	1608	2003	
	20-			\$1257	1608	2003	
26-42	18-			\$1422	1817	2257	
	20-			\$1422	1817	2257	

Step 5. Paint/Steel Type		
SS	smooth paint on smooth steel	+\$0
TS	smooth paint on textured steel	+\$35
XS	textured paint on smooth steel	+\$0

Step 6. Surface Finish		
Nonmetallic Paint		
<i>For smooth paint on smooth steel (SS) or smooth paint on textured steel (TS)</i>		
8Q	folkstone grey	+\$0
91	white	+\$0
98	studio white A	+\$0
9J	sparrow	+\$0
BU	black umber	+\$0
CL	cool grey neutral	+\$0
G2	graphite satin	+\$0
HF	inner tone light	+\$0
HT	inner tone	+\$0
LT	light tone	+\$0
LU	soft white	+\$0
MT	medium tone	+\$0
SG	slate grey	+\$0
WA	wheat	+\$0
WL	sandstone	+\$0

Metallic Paint		
<i>For smooth paint on smooth steel (SS) or smooth paint on textured steel (TS)</i>		
1209	platinum	+\$0
1210	hematite	+\$0
1212	bronzite	+\$0
CN	metallic champagne	+\$0
EH	metallic bronze	+\$0
MS	metallic silver	+\$0

Sand Texture Paint		
<i>For textured paint on smooth steel (XS)</i>		
98	studio white A	+\$0

Bright Sand Texture Paint		
<i>For textured paint on smooth steel (XS)</i>		
91	white	+\$0
CL	cool grey neutral	+\$0
G1	graphite	+\$0
WN	warm grey neutral	+\$0

Standard-Pull Freestanding Lateral File *continued*

Step 7. Top

NT	no top	+\$0
T1	1"-high painted metal top with squared edge	+\$0
T2	1¼"-high painted metal top with squared edge	+\$0
T3	1¼"-high painted metal top with radius edge	+\$65
TL	1¼"-high laminate top with thermoplastic edge	+\$74
TR	1¼"-high recut veneer top A	+\$150
TF	1¼"-high wood veneer top A	+\$156
T7	6½"-high planter top	+\$200
D1	6½"-high full dome, side-to-side	+\$273
H1	6½"-high half dome, sloping left	+\$273
H2	6½"-high half dome, sloping right	+\$273
TV1	1⅛"-high wood veneer top and wood composite edge with oversail front A	+\$321
TC1	1" cushion top	+\$394
TC2	2" cushion top	+\$394

Step 8. Veneer Top Finish

Wood Veneer

For 1⅛"-high wood veneer top and wood composite edge with oversail front (TV1)

40	dark brown walnut A	+\$28
ED	aged cherry A	+\$28
EK	medium red walnut A	+\$28
EW	medium matte walnut A	+\$28
ET	clear on ash A	+\$28
EU	oak on ash A	+\$28
EV	walnut on ash A	+\$28
UL	natural maple A	+\$28
UX	walnut on cherry A	+\$28

Wood Veneer

For 1¼"-high wood veneer top (TF)

2U	light brown walnut A	+\$28
40	dark brown walnut A	+\$28
ED	aged cherry A	+\$28
EK	medium red walnut A	+\$28
EW	medium matte walnut A	+\$28
ET	clear on ash A	+\$28
EU	oak on ash A	+\$28
EV	walnut on ash A	+\$28
UL	natural maple A	+\$28
UX	walnut on cherry A	+\$28

Recut Veneer

For 1¼"-high recut veneer top (TR)

RA	light ash A	+\$0
RK	mahogany dark A	+\$0
RM	mahogany A	+\$0

Step 9. Top Finish

For 1¼"-high laminate top with thermoplastic edge (TL)

Solid-Color Laminate

8Q	folkstone grey	+\$0
91	white	+\$0
98	studio white	+\$0
CL	cool grey neutral	+\$0
HF	inner tone light	+\$0
HT	inner tone	+\$0
LT	light tone	+\$0
LU	soft white	+\$0
WL	sandstone	+\$0
WN	warm grey neutral	+\$0

Linen Laminate

LBM	crisp linen	+\$0
LBN	classic linen	+\$0
LBP	casual linen	+\$0

Mesh Laminate

LBK	pewter mesh	+\$0
LBL	steel mesh	+\$0

Twill Laminate

LBF	neutral twill	+\$0
LBG	sarum twill	+\$0
LBH	earthen twill	+\$0
LBJ	graphite twill	+\$0
LBQ	white twill	+\$0

Standard-Pull Freestanding Lateral File *continued*

Meridian® Freestanding Stackable™ Lateral Files

Wood-Grain Laminate		
HM	natural maple	+\$0
HP	light anigre	+\$0
LA	light ash	+\$0
LBA	clear on ash	+\$0
LBB	oak on ash	+\$0
LBC	walnut on ash	+\$0
LBD	dark brown walnut	+\$0
LBR	phantom ecru	+\$0
LBS	phantom cocoa	+\$0
LBU	medium matte walnut	+\$0
LBV	warm grey teak	+\$0
LBE	medium red walnut	+\$0
LM	mahogany	+\$0
76	light brown walnut	+\$0
HX	aged cherry	+\$0
HY	walnut on cherry	+\$0

Zephyr Laminate		
28	canyon	+\$0
29	misted	+\$0

Step 10. Edge Finish		
<i>For 1 1/4"-high laminate top with thermoplastic edge (TL)</i>		
28	canyon	+\$0
29	misted	+\$0
76	light brown walnut	+\$0
8Q	folkstone grey	+\$0
91	white	+\$0
98	studio white	+\$0
BU	black umber	+\$0
CL	cool grey neutral	+\$0
G2	graphite satin	+\$0
HF	inner tone light	+\$0
HM	natural maple	+\$0
HP	light anigre	+\$0
HT	inner tone	+\$0
HX	aged cherry	+\$0
HY	walnut on cherry	+\$0
LA	light ash	+\$0
LBA	clear on ash	+\$0
LBB	oak on ash	+\$0
LBC	walnut on ash	+\$0
LBD	dark brown walnut	+\$0
LBR	phantom ecru	+\$0
LBS	phantom cocoa	+\$0
LBU	medium matte walnut	+\$0

LBV	warm grey teak	+\$0
LBE	medium red walnut	+\$0
LBK	pewter mesh	+\$0
LBL	steel mesh	+\$0
LBM	crisp linen	+\$0
LBN	classic linen	+\$0
LBP	casual linen	+\$0
LBF	neutral twill	+\$0
LBG	sarum twill	+\$0
LBH	earthen twill	+\$0
LBJ	graphite twill	+\$0
LBQ	white twill	+\$0
LM	mahogany	+\$0
LU	soft white	+\$0
MT	medium tone	+\$0
SG	slate grey	+\$0
WA	wheat	+\$0
WL	sandstone	+\$0
WN	warm grey neutral	+\$0

Step 11. Cushion Top Fabric	
<i>For 1" cushion top (TC1) or 2" cushion top (TC2)</i>	
<i>See application chart and textiles list for fabric usage and numbers.</i>	
<i>First 2 digits of number indicate fabric line; remaining digit(s) indicate fabric color.</i>	
Price Category 1	+\$0
Price Category 2	+\$68
Price Category 3	+\$82
Price Category 4	+\$101
Price Category 5	+\$120
Price Category 7	+\$137
Price Category 8	+\$725
Price Category 9	+\$950
Price Category (Geiger) 10	+\$1050
Price Category B	+\$47
Price Category C	+\$65
Price Category D	+\$82
Price Category E	+\$99
Price Category F	+\$141
Price Category G	+\$166
Price Category H	+\$204
Price Category I	+\$264
Price Category J	+\$276
Price Category K	+\$310

Standard-Pull Freestanding Lateral File *continued*

Step 12. Lock		
KA	keyed alike	-\$10
KC	keyed differently, chrome	+\$0
KD	keyed differently, black	+\$0

Step 13. Base Height		
B1	1"-high base	+\$0
B2	1½"-high base	+\$0
B3	2¼"-high base	+\$0
B4	3¼"-high base	+\$0
BA	1"-high recessed base	+\$34
BB	1½"-high recessed base	+\$34
BC	2¼"-high recessed base	+\$34
BD	3¼"-high recessed base	+\$34
B5	4¼"-high base	+\$34
LB2	1½" leg base	+\$34

Step 14. Leg <i>For 1½" leg base (LB2)</i>		
DD	2"-high canvas leg	+\$125

Step 15. Leg Finish		
91	white	+\$0
98	studio white	+\$0
CL	cool grey neutral	+\$0
G1	graphite	+\$0
WN	warm grey neutral	+\$0

Metallic Paint		
CN	metallic champagne	+\$0
EH	metallic bronze	+\$0
MS	metallic silver	+\$0

Step 16. Counterweight		
NO	no counterweight (must gang or anchor)	+\$0
CB	counterweight (recommended)	+\$122

Step 17. Drawer Interior		
9M	3 dividers	+\$0
9P	front-to-back filing rail	+\$0
9R	side-to-side filing rail	+\$0

Arc-Pull Freestanding Lateral File

2A-30
2A-36
2A-42
2D-30
2D-36
2D-42

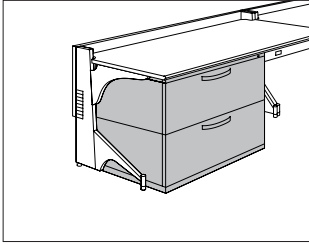

Product Information

Description

This lateral file holds letter-, legal-, and A4-size hanging files. It has arc pulls and smooth or textured steel. The file has no top or a metal, cushion, laminate, planter, or veneer top. A positive interlock system permits only 1 drawer to open at a time. 1 lock controls all drawers. The drawers can be specified with 3 dividers or with front-to-back or side-to-side filing rails for hanging files. 5 base heights are available; all bases include adjustable glides.

Actual lateral file widths are $29\frac{7}{8}$ " , $35\frac{7}{8}$ " , or $41\frac{7}{8}$ " ; actual depths are $17\frac{7}{8}$ " or $19\frac{7}{8}$ " .

Notes

For 2- or 3-high files that are not ganged or anchored, counterweights (option CB) are required. For 4- or 5-high files that are not ganged or anchored, counterweights are recommended.

For base height option (LB2), legs will be shipped separately.

For base height option (LB2), overall height is $3\frac{1}{2}$ " consisting of $1\frac{1}{2}$ " tube base with 2" legs.

Dimensional illustrations do not include all possible configurations.

To convert filing direction, order 1 of the following products separately:

- Front-to-back rail (gPxxxx)
- Side-to-side rail (gRxxxx)

See Stackable Lateral File Accessories for specific product number.

Order optional file drawer organizer (LG901) separately.

For work surface on top of 1 or more lateral files, order file top (TPL or TPV) separately.

No lock option (NL) can only be specified on files with no top (NT), dome tops (D1, H1, or H2), planter top (T7), laminate tops (TL), or veneer top (TV1).

For cushion tops TC1 and TC2, a 1" metal top is included.

Grain direction is vertical for veneer-front lateral files.

Cushion top accepts Customer's Own Material (COM). Yardage is estimated for nondirectional, 54"-wide fabrics. When ordering more than 1 cushion, round up total yardage requirement to next whole yard of fabric.

Width—Yardage

30" —1.05

36" —1.22

42" —1.40

For information on multiple quantities or directional fabrics, contact COM Department. See Order Information in Appendices.

For keyed-alike locks, order lock plugs separately. See Keyed-Alike Information in Appendices.

The arc pull conforms to guidelines of the Americans with Disabilities Act (ADA).

Dimensions

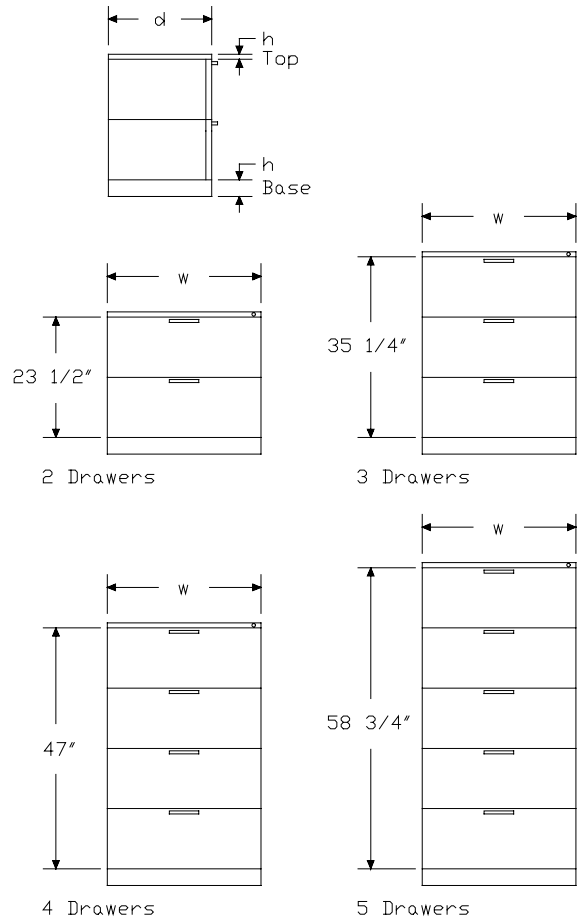

Arc-Pull Freestanding Lateral File

continued

Meridian® Freestanding Stackable™ Lateral Files

Specification Information

Step 1.

2

Step 2. Front Material

- D- painted metal front
- A- veneer front A

Step 3. Width

- 30 30" wide
- 36 36" wide
- 42 42" wide

Step 4. Depth

- 18- 18" deep
- 20- 20" deep

Step 5. Configuration

- 2N 2 drawers
- 3N 3 drawers
- 4N 4 drawers
- 5N 5 drawers

Prices for Steps 1-5.

	2N	3N	4N	5N
2D-30 18-	\$860	1180	1501	1821
20-	\$860	1180	1501	1821
2D-36 18-	\$950	1300	1651	2001
20-	\$950	1300	1651	2001
2D-42 18-	\$1070	1464	1860	2256
20-	\$1070	1464	1860	2256
2A-30 18-	\$1194	1683	2169	2660
20-	\$1194	1683	2169	2660
2A-36 18-	\$1351	1903	2455	3005
20-	\$1351	1903	2455	3005
2A-42 18-	\$1535	2162	2792	3419
20-	\$1535	2162	2792	3419

Step 6. Paint/Steel Type

- SS smooth paint on smooth steel +\$0
- TS smooth paint on textured steel +\$35
- XS textured paint on smooth steel +\$0

Step 7. Surface Finish

Nonmetallic Paint

For smooth paint on smooth steel (SS) or smooth paint on textured steel (TS)

8Q	folkstone grey	+\$0
91	white	+\$0
98	studio white A	+\$0
9J	sparrow	+\$0
BU	black umber	+\$0
G2	graphite satin	+\$0
HF	inner tone light	+\$0
HT	inner tone	+\$0
LT	light tone	+\$0
LU	soft white	+\$0
MT	medium tone	+\$0
SG	slate grey	+\$0
WA	wheat	+\$0
WL	sandstone	+\$0

Metallic Paint

For smooth paint on smooth steel (SS) or smooth paint on textured steel (TS)

1209	platinum	+\$0
1210	hematite	+\$0
1212	bronzite	+\$0
CN	metallic champagne	+\$0
EH	metallic bronze	+\$0
MS	metallic silver	+\$0

Sand Texture Paint

For textured paint on smooth steel (XS)

98	studio white A	+\$0
-----------	--	------

Bright Sand Texture Paint

For textured paint on smooth steel (XS)

91	white	+\$0
CL	cool grey neutral	+\$0
G1	graphite	+\$0
WN	warm grey neutral	+\$0

Arc-Pull Freestanding Lateral File

continued

Meridian® Freestanding Stackable™ Lateral Files

Step 8. Top

For painted metal front (D-)

NT	no top	+\$0
T1	1"-high painted metal top with squared edge	+\$0
T2	1¼"-high painted metal top with squared edge	+\$0
T3	1¼"-high painted metal top with radius edge	+\$65
TL	1¼"-high laminate top with thermoplastic edge	+\$74
TR	1¼"-high recut veneer top <input type="checkbox"/> A	+\$150
TF	1¼"-high wood veneer top <input type="checkbox"/> A	+\$156
T7	6½"-high planter top	+\$200
D1	6½"-high full dome, side-to-side	+\$273
H1	6½"-high half dome, sloping left	+\$273
H2	6½"-high half dome, sloping right	+\$273
TV1	1⅛"-high wood veneer top and wood composite edge with oversail front <input type="checkbox"/> A	+\$321
TC1	1" cushion top	+\$394
TC2	2" cushion top	+\$394

For veneer front (A-)

NT	no top	+\$0
T1	1"-high painted metal top with squared edge	+\$0
T2	1¼"-high painted metal top with squared edge	+\$0
T3	1¼"-high painted metal top with radius edge	+\$65
TL	1¼"-high laminate top with thermoplastic edge	+\$74
TF	1¼"-high wood veneer top <input type="checkbox"/> A	+\$156
T7	6½"-high planter top	+\$200
D1	6½"-high full dome, side-to-side	+\$273
H1	6½"-high half dome, sloping left	+\$273
H2	6½"-high half dome, sloping right	+\$273
TV1	1⅛"-high wood veneer top and wood composite edge with oversail front <input type="checkbox"/> A	+\$321
TC1	1" cushion top	+\$394
TC2	2" cushion top	+\$394

Step 9.

Veneer Top Finish: Wood Veneer

For 1¼"-high wood veneer top (TF)

2U	light brown walnut <input type="checkbox"/> A	+\$28
40	dark brown walnut <input type="checkbox"/> A	+\$28
ED	aged cherry <input type="checkbox"/> A	+\$28
EK	medium red walnut <input type="checkbox"/> A	+\$28
EW	medium matte walnut <input type="checkbox"/> A	+\$28
ET	clear on ash <input type="checkbox"/> A	+\$28
EU	oak on ash <input type="checkbox"/> A	+\$28
EV	walnut on ash <input type="checkbox"/> A	+\$28
UL	natural maple <input type="checkbox"/> A	+\$28
UX	walnut on cherry <input type="checkbox"/> A	+\$28

Veneer Front Finish: Wood Veneer

For no top (NT), 1"-high painted metal top with squared edge (T1), 1¼"-high painted metal top with squared edge (T2), 1¼"-high painted metal top with radius edge (T3), 1¼"-high laminate top with thermoplastic edge (TL), 6½"-high planter top (T7), 6½"-high full dome, side-to-side (D1), 6½"-high half dome, sloping left (H1), 6½"-high half dome, sloping right (H2), 1" cushion top (TC1), or 2" cushion top (TC2)

2U	light brown walnut <input type="checkbox"/> A	+\$56
40	dark brown walnut <input type="checkbox"/> A	+\$56
ED	aged cherry <input type="checkbox"/> A	+\$56
EK	medium red walnut <input type="checkbox"/> A	+\$56
EW	medium matte walnut <input type="checkbox"/> A	+\$56
ET	clear on ash <input type="checkbox"/> A	+\$56
EU	oak on ash <input type="checkbox"/> A	+\$56
EV	walnut on ash <input type="checkbox"/> A	+\$56
UL	natural maple <input type="checkbox"/> A	+\$56
UX	walnut on cherry <input type="checkbox"/> A	+\$56

Veneer Top Finish: Wood Veneer

For 1⅛"-high wood veneer top and wood composite edge with oversail front (TV1)

40	dark brown walnut <input type="checkbox"/> A	+\$28
ED	aged cherry <input type="checkbox"/> A	+\$28
EK	medium red walnut <input type="checkbox"/> A	+\$28
EW	medium matte walnut <input type="checkbox"/> A	+\$28
ET	clear on ash <input type="checkbox"/> A	+\$28
EU	oak on ash <input type="checkbox"/> A	+\$28
EV	walnut on ash <input type="checkbox"/> A	+\$28
UL	natural maple <input type="checkbox"/> A	+\$28
UX	walnut on cherry <input type="checkbox"/> A	+\$28

Arc-Pull Freestanding Lateral File

continued

Veneer Front/Top Finish: Wood Veneer

For 1¹/₈"-high wood veneer top and wood composite edge with oversail front (TV₁)

40	dark brown walnut <input type="checkbox"/>	+\$56
ED	aged cherry <input type="checkbox"/>	+\$56
EK	medium red walnut <input type="checkbox"/>	+\$56
EW	medium matte walnut <input type="checkbox"/>	+\$56
ET	clear on ash <input type="checkbox"/>	+\$56
EU	oak on ash <input type="checkbox"/>	+\$56
EV	walnut on ash <input type="checkbox"/>	+\$56
UL	natural maple <input type="checkbox"/>	+\$56
UX	walnut on cherry <input type="checkbox"/>	+\$56

Veneer Top Finish: Recut Veneer

For 1¹/₄"-high recut veneer top (TR)

RA	light ash <input type="checkbox"/>	+\$0
RK	mahogany dark <input type="checkbox"/>	+\$0
RM	mahogany <input type="checkbox"/>	+\$0

Veneer Front/Top Finish: Wood Veneer

For 1¹/₄"-high wood veneer top (TF)

2U	light brown walnut <input type="checkbox"/>	+\$56
40	dark brown walnut <input type="checkbox"/>	+\$56
ED	aged cherry <input type="checkbox"/>	+\$56
EK	medium red walnut <input type="checkbox"/>	+\$56
EW	medium matte walnut <input type="checkbox"/>	+\$56
ET	clear on ash <input type="checkbox"/>	+\$56
EU	oak on ash <input type="checkbox"/>	+\$56
EV	walnut on ash <input type="checkbox"/>	+\$56
UL	natural maple <input type="checkbox"/>	+\$56
UX	walnut on cherry <input type="checkbox"/>	+\$56

Step 10. Top Finish

For 1¹/₄"-high laminate top with thermoplastic edge (TL)

Solid-Color Laminate

8Q	folkstone grey	+\$0
91	white	+\$0
98	studio white	+\$0
CL	cool grey neutral	+\$0
HF	inner tone light	+\$0
HT	inner tone	+\$0
LT	light tone	+\$0
LU	soft white	+\$0
WL	sandstone	+\$0
WN	warm grey neutral	+\$0

Linen Laminate

LBM	crisp linen	+\$0
LBN	classic linen	+\$0
LBP	casual linen	+\$0

Mesh Laminate

LBK	pewter mesh	+\$0
LBL	steel mesh	+\$0

Twill Laminate

LBF	neutral twill	+\$0
LBG	sarum twill	+\$0
LBH	earthen twill	+\$0
LBJ	graphite twill	+\$0
LBQ	white twill	+\$0

Wood-Grain Laminate

HM	natural maple	+\$0
HP	light anigre	+\$0
LA	light ash	+\$0
LBA	clear on ash	+\$0
LBB	oak on ash	+\$0
LBC	walnut on ash	+\$0
LBD	dark brown walnut	+\$0
LBR	phantom ecru	+\$0
LBS	phantom cocoa	+\$0
LBU	medium matte walnut	+\$0
LBV	warm grey teak	+\$0
LBE	medium red walnut	+\$0
LM	mahogany	+\$0
76	light brown walnut	+\$0
HX	aged cherry	+\$0
HY	walnut on cherry	+\$0

Zephyr Laminate

28	canyon	+\$0
29	misted	+\$0

Step 11. Edge Finish

For 1¹/₄"-high laminate top with thermoplastic edge (TL)

28	canyon	+\$0
29	misted	+\$0
76	light brown walnut	+\$0
8Q	folkstone grey	+\$0
91	white	+\$0
98	studio white	+\$0
BU	black umber	+\$0

Arc-Pull Freestanding Lateral File

continued

Meridian® Freestanding Stackable™ Lateral Files

CL	cool grey neutral	+\$0
G2	graphite satin	+\$0
HF	inner tone light	+\$0
HM	natural maple	+\$0
HP	light anigre	+\$0
HT	inner tone	+\$0
HX	aged cherry	+\$0
HY	walnut on cherry	+\$0
LA	light ash	+\$0
LBA	clear on ash	+\$0
LBB	oak on ash	+\$0
LBC	walnut on ash	+\$0
LBD	dark brown walnut	+\$0
LBR	phantom ecru	+\$0
LBS	phantom cocoa	+\$0
LBU	medium matte walnut	+\$0
LBV	warm grey teak	+\$0
LBE	medium red walnut	+\$0
LBK	pewter mesh	+\$0
LBL	steel mesh	+\$0
LBM	crisp linen	+\$0
LBN	classic linen	+\$0
LBP	casual linen	+\$0
LBF	neutral twill	+\$0
LBG	sarum twill	+\$0
LBH	earthen twill	+\$0
LBJ	graphite twill	+\$0
LBQ	white twill	+\$0
LM	mahogany	+\$0
LU	soft white	+\$0
MT	medium tone	+\$0
SG	slate grey	+\$0
WA	wheat	+\$0
WL	sandstone	+\$0
WN	warm grey neutral	+\$0

Step 12. Cushion Top Fabric

For 1" cushion top (TC1) or 2" cushion top (TC2)
See textiles list for fabric numbers. First 2 digits of number indicate fabric line; remaining digit(s) indicate fabric color.

Price Category 1	+\$0
Price Category 2	+\$68
Price Category 3	+\$82
Price Category 4	+\$101
Price Category 5	+\$120
Price Category 7	+\$137
Price Category 8	+\$725
Price Category 9	+\$950
Price Category (Geiger) 10	+\$1050
Price Category B	+\$47
Price Category C	+\$65
Price Category D	+\$82
Price Category E	+\$99
Price Category F	+\$141
Price Category G	+\$166
Price Category H	+\$204
Price Category I	+\$264
Price Category J	+\$276
Price Category K	+\$310

Step 13. Lock

For no top (NT), 1¹/₄"-high laminate top with thermoplastic edge (TL), 6¹/₂"-high planter top (T7), 6¹/₂"-high full dome, side-to-side (D1), 6¹/₂"-high half dome, sloping left (H1), 6¹/₂"-high half dome, sloping right (H2), or 1¹/₈"-high wood veneer top and wood composite edge with oversail front (TV1)

NL	no lock	-\$30
-----------	---------	-------

For 1"-high painted metal top with squared edge (T1), 1¹/₄"-high painted metal top with squared edge (T2), 1¹/₄"-high painted metal top with radius edge (T3), 1¹/₄"-high recut veneer top (TR), 1¹/₄"-high wood veneer top (TF), 1" cushion top (TC1), or 2" cushion top (TC2)

KA	keyed alike	-\$10
KC	keyed differently, chrome	+\$0
KD	keyed differently, black	+\$0

Step 14. Pull Finish

NH	brushed nickel	+\$0
NK	black nickel	+\$0

Arc-Pull Freestanding Lateral File

continued

Step 15. Base Height		
B1	1"-high base	+\$0
B2	1½"-high base	+\$0
B3	2¼"-high base	+\$0
B4	3¼"-high base	+\$0
BA	1"-high recessed base	+\$34
BB	1½"-high recessed base	+\$34
BC	2¼"-high recessed base	+\$34
BD	3¼"-high recessed base	+\$34
B5	4¼"-high base	+\$34
LB2	1½" leg base	+\$34

Step 16. Leg		
<i>For 1½" leg base (LB2)</i>		
DD	2"-high canvas leg	+\$125

Step 17. Leg Finish		
91	white	+\$0
CL	cool grey neutral	+\$0
G1	graphite	+\$0
WN	warm grey neutral	+\$0

Metallic Paint		
CN	metallic champagne	+\$0
EH	metallic bronze	+\$0
MS	metallic silver	+\$0

Step 18. Counterweight		
NO	no counterweight (must gang or anchor)	+\$0
CB	counterweight (recommended)	+\$122

Step 19. Drawer Interior		
9P	front-to-back filing rail	+\$0
9R	side-to-side filing rail	+\$0
9M	3 dividers	+\$0

Bar-Pull Freestanding Lateral File

2KP-3
2KP-4
2KV-3
2KV-4

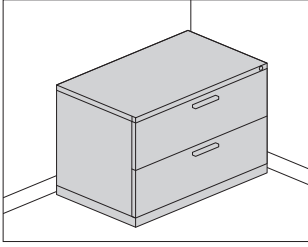

Product Information

Description

This lateral file holds letter-, legal-, and A4-size hanging files. It has bar pulls and smooth or textured steel. The file has no top or a metal, cushion, laminate, planter, or veneer top. A positive interlock system permits only 1 drawer to open at a time. 1 lock controls all drawers. The drawers can be specified with 3 dividers or with front-to-back or side-to-side filing rails for hanging files. 5 base heights are available; all bases include adjustable glides.

Actual lateral file widths are $29\frac{7}{8}$ " , $35\frac{7}{8}$ " , or $41\frac{7}{8}$ " ; actual depths are $17\frac{7}{8}$ " or $19\frac{7}{8}$ " .

Notes

For 2- or 3-high files that are not ganged or anchored, counterweights (option CB) are required. For 4- or 5-high files that are not ganged or anchored, counterweights are recommended.

For base height option (LB2), legs will be shipped separately.

For base height option (LB2), overall height is $3\frac{1}{2}$ " consisting of $1\frac{1}{2}$ " tube base with 2" legs.

Dimensional illustrations do not include all possible configurations.

To convert filing direction, order 1 of the following products separately:

- Front-to-back rail (gPxxxx)
- Side-to-side rail (gRxxxx)

See Stackable Lateral File Accessories for specific product number.

Order optional file drawer organizer (LG901) separately.

For work surface on top of 1 or more lateral files, order file top (TPL or TPV) separately.

No lock option (NL) can only be specified on files with no top (NT), dome tops (D1, H1, or H2), planter top (T7), laminate tops (TL), or veneer top (TV1).

For cushion tops TC1 and TC2, a 1" metal top is included.

Grain direction is vertical for veneer-front lateral files.

Cushion top accepts Customer's Own Material (COM). Yardage is estimated for nondirectional, 54"-wide fabrics. When ordering more than 1 cushion, round up total yardage requirement to next whole yard of fabric.

Width—Yardage

30"—1.05

36"—1.22

42"—1.40

For information on multiple quantities or directional fabrics, contact COM Department. See Order Information in Appendices.

For keyed-alike locks, order lock plugs separately. See Keyed-Alike Information in Appendices.

Dimensions

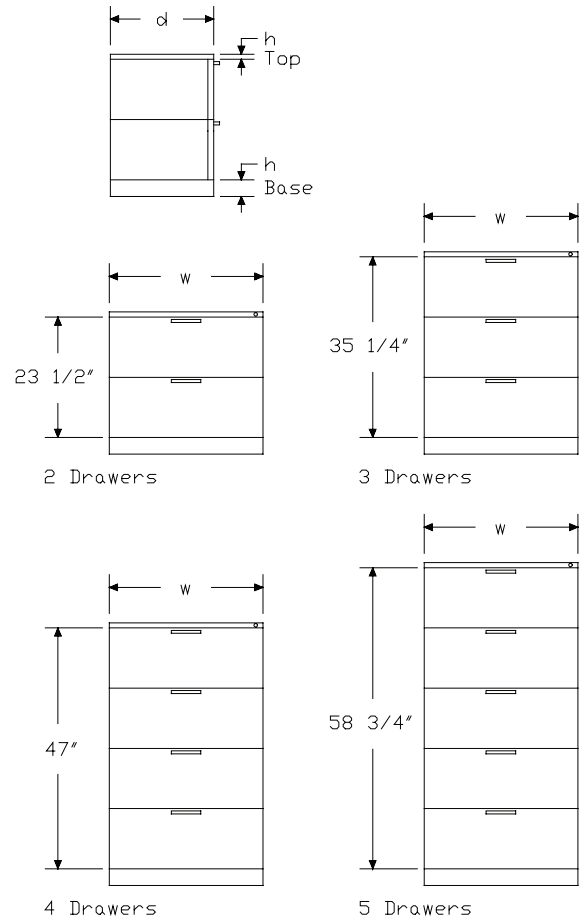

Bar-Pull Freestanding Lateral File

continued

Meridian® Freestanding Stackable™ Lateral Files

Specification Information

Step 1.

2K

Step 2. Front Material

P- painted metal front
V- veneer front

Step 3. Width

30 30" wide
36 36" wide
42 42" wide

Step 4. Depth

18- 18" deep
20- 20" deep

Step 5. Configuration

2N 2 drawers
3N 3 drawers
4N 4 drawers
5N 5 drawers

Prices for Steps 1-5.

	2N	3N	4N	5N
2KP-30 18-	\$859	1180	1501	1821
20-	\$859	1180	1501	1821
2KP-36 18-	\$950	1300	1651	2001
20-	\$950	1300	1651	2001
2KP-42 18-	\$1070	1464	1860	2257
20-	\$1070	1464	1860	2257
2KV-30 18-	\$1194	1683	2282	2660
20-	\$1194	1683	2282	2660
2KV-36 18-	\$1351	1903	2455	3005
20-	\$1351	1903	2455	3005
2KV-42 18-	\$1535	2162	2792	3419
20-	\$1535	2162	2792	3419

Step 6. Paint/Steel Type

SS smooth paint on smooth steel +\$0
TS smooth paint on textured steel +\$35
XS textured paint on smooth steel +\$0

Step 7. Surface Finish

Nonmetallic Paint

For smooth paint on smooth steel (SS) or smooth paint on textured steel (TS)

8Q	folkstone grey	+\$0
91	white	+\$0
98	studio white A	+\$0
9J	sparrow	+\$0
BU	black umber	+\$0
G2	graphite satin	+\$0
HF	inner tone light	+\$0
HT	inner tone	+\$0
LT	light tone	+\$0
LU	soft white	+\$0
MT	medium tone	+\$0
SG	slate grey	+\$0
WA	wheat	+\$0
WL	sandstone	+\$0

Metallic Paint

For smooth paint on smooth steel (SS) or smooth paint on textured steel (TS)

1209	platinum	+\$0
1210	hematite	+\$0
1212	bronzite	+\$0
CN	metallic champagne	+\$0
EH	metallic bronze	+\$0
MS	metallic silver	+\$0

Sand Texture Paint

For textured paint on smooth steel (XS)

98	studio white A	+\$0
-----------	-----------------------	------

Bright Sand Texture Paint

For textured paint on smooth steel (XS)

91	white	+\$0
CL	cool grey neutral	+\$0
G1	graphite	+\$0
WN	warm grey neutral	+\$0

Bar-Pull Freestanding Lateral File

continued

Meridian® Freestanding Stackable™ Lateral Files

Step 8. Top

For painted metal front (P-)

NT	no top	+\$0
T1	1"-high painted metal top with squared edge	+\$0
T2	1¼"-high painted metal top with squared edge	+\$0
T3	1¼"-high painted metal top with radius edge	+\$65
TL	1¼"-high laminate top with thermoplastic edge	+\$74
TR	1¼"-high recut veneer top <input type="checkbox"/> A	+\$150
TF	1¼"-high wood veneer top <input type="checkbox"/> A	+\$156
T7	6½"-high planter top	+\$200
D1	6½"-high full dome, side-to-side	+\$273
H1	6½"-high half dome, sloping left	+\$273
H2	6½"-high half dome, sloping right	+\$273
TV1	1⅝"-high wood veneer top and wood composite edge with oversail front <input type="checkbox"/> A	+\$321
TC1	1" cushion top	+\$394
TC2	2" cushion top	+\$394

For veneer front (V-)

NT	no top	+\$0
T1	1"-high painted metal top with squared edge	+\$0
T2	1¼"-high painted metal top with squared edge	+\$0
T3	1¼"-high painted metal top with radius edge	+\$65
TL	1¼"-high laminate top with thermoplastic edge	+\$74
TF	1¼"-high wood veneer top <input type="checkbox"/> A	+\$156
T7	6½"-high planter top	+\$200
D1	6½"-high full dome, side-to-side	+\$273
H1	6½"-high half dome, sloping left	+\$273
H2	6½"-high half dome, sloping right	+\$273
TV1	1⅝"-high wood veneer top and wood composite edge with oversail front <input type="checkbox"/> A	+\$321
TC1	1" cushion top	+\$394
TC2	2" cushion top	+\$394

Step 9.

Veneer Top Finish: Wood Veneer

For painted metal front (P-) with 1¼"-high wood veneer top (TF)

2U	light brown walnut <input type="checkbox"/> A	+\$28
40	dark brown walnut <input type="checkbox"/> A	+\$28
ED	aged cherry <input type="checkbox"/> A	+\$28
EK	medium red walnut <input type="checkbox"/> A	+\$28
EW	medium matte walnut <input type="checkbox"/> A	+\$28
ET	clear on ash <input type="checkbox"/> A	+\$28
EV	walnut on ash <input type="checkbox"/> A	+\$28
UL	natural maple <input type="checkbox"/> A	+\$28
UX	walnut on cherry <input type="checkbox"/> A	+\$28

Veneer Front Finish: Wood Veneer

For veneer front (V-) with no top (NT), 1"-high painted metal top with squared edge (T1), 1¼"-high painted metal top with squared edge (T2), 1¼"-high painted metal top with radius edge (T3), 1¼"-high laminate top with thermoplastic edge (TL), 6½"-high planter top (T7), 6½"-high full dome, side-to-side (D1), 6½"-high half dome, sloping left (H1), 6½"-high half dome, sloping right (H2), or 1" cushion top (TC1), or 2" cushion top (TC2)

2U	light brown walnut <input type="checkbox"/> A	+\$56
40	dark brown walnut <input type="checkbox"/> A	+\$56
ED	aged cherry <input type="checkbox"/> A	+\$56
EK	medium red walnut <input type="checkbox"/> A	+\$56
EW	medium matte walnut <input type="checkbox"/> A	+\$56
ET	clear on ash <input type="checkbox"/> A	+\$56
EV	walnut on ash <input type="checkbox"/> A	+\$56
UL	natural maple <input type="checkbox"/> A	+\$56
UX	walnut on cherry <input type="checkbox"/> A	+\$56

Veneer Top Finish: Wood Veneer

For painted metal front (P-) with 1⅝"-high wood veneer top and wood composite edge with oversail front (TV1)

40	dark brown walnut <input type="checkbox"/> A	+\$28
ED	aged cherry <input type="checkbox"/> A	+\$28
EK	medium red walnut <input type="checkbox"/> A	+\$28
EW	medium matte walnut <input type="checkbox"/> A	+\$28
ET	clear on ash <input type="checkbox"/> A	+\$28
EV	walnut on ash <input type="checkbox"/> A	+\$28
UL	natural maple <input type="checkbox"/> A	+\$28
UX	walnut on cherry <input type="checkbox"/> A	+\$28

Bar-Pull Freestanding Lateral File

continued

Veneer Front/Top Finish: Wood Veneer		
<i>For veneer front (V-) with 1 1/8"-high wood veneer top and wood composite edge with oversail front (TV1)</i>		
40	dark brown walnut <input type="checkbox"/>	+\$56
ED	aged cherry <input type="checkbox"/>	+\$56
EK	medium red walnut <input type="checkbox"/>	+\$56
EW	medium matte walnut <input type="checkbox"/>	+\$56
ET	clear on ash <input type="checkbox"/>	+\$56
EV	walnut on ash <input type="checkbox"/>	+\$56
UL	natural maple <input type="checkbox"/>	+\$56
UX	walnut on cherry <input type="checkbox"/>	+\$56

Veneer Top Finish: Recut Veneer		
<i>For painted metal front (P-) with 1 1/4"-high recut veneer top (TR)</i>		
RA	light ash <input type="checkbox"/>	+\$0
RK	mahogany dark <input type="checkbox"/>	+\$0
RM	mahogany <input type="checkbox"/>	+\$0

Veneer Front/Top Finish: Wood Veneer		
<i>For veneer front (V-) with 1 1/4"-high wood veneer top (TF)</i>		
2U	light brown walnut <input type="checkbox"/>	+\$56
40	dark brown walnut <input type="checkbox"/>	+\$56
ED	aged cherry <input type="checkbox"/>	+\$56
EK	medium red walnut <input type="checkbox"/>	+\$56
EW	medium matte walnut <input type="checkbox"/>	+\$56
ET	clear on ash <input type="checkbox"/>	+\$56
EV	walnut on ash <input type="checkbox"/>	+\$56
UL	natural maple <input type="checkbox"/>	+\$56
UX	walnut on cherry <input type="checkbox"/>	+\$56

Step 10. Top Finish
For 1 1/4"-high laminate top with thermoplastic edge (TL)

Solid-Color Laminate		
8Q	folkstone grey	+\$0
91	white	+\$0
98	studio white	+\$0
CL	cool grey neutral	+\$0
HF	inner tone light	+\$0
HT	inner tone	+\$0
LT	light tone	+\$0
LU	soft white	+\$0
WL	sandstone	+\$0
WN	warm grey neutral	+\$0

Linen Laminate		
LBM	crisp linen	+\$0
LBN	classic linen	+\$0
LBP	casual linen	+\$0

Mesh Laminate		
LBK	pewter mesh	+\$0
LBL	steel mesh	+\$0

Twill Laminate		
LBF	neutral twill	+\$0
LBG	sarum twill	+\$0
LBH	earthen twill	+\$0
LBJ	graphite twill	+\$0
LBQ	white twill	+\$0

Wood-Grain Laminate		
HM	natural maple	+\$0
HP	light anigre	+\$0
LA	light ash	+\$0
LBA	clear on ash	+\$0
LBB	oak on ash	+\$0
LBC	walnut on ash	+\$0
LBD	dark brown walnut	+\$0
LBR	phantom ecru	+\$0
LBS	phantom cocoa	+\$0
LBU	medium matte walnut	+\$0
LBV	warm grey teak	+\$0
LBE	medium red walnut	+\$0
LM	mahogany	+\$0
76	light brown walnut	+\$0
HX	aged cherry	+\$0
HY	walnut on cherry	+\$0

Zephyr Laminate		
28	canyon	+\$0
29	misted	+\$0

Step 11. Edge Finish
For 1 1/4"-high laminate top with thermoplastic edge (TL)

28	canyon	+\$0
29	misted	+\$0
76	light brown walnut	+\$0
8Q	folkstone grey	+\$0
91	white	+\$0
98	studio white	+\$0
BU	black umber	+\$0

Meridian® Freestanding Stackable™ Lateral Files

Bar-Pull Freestanding Lateral File

continued

Meridian® Freestanding Stackable™ Lateral Files

CL	cool grey neutral	+\$0
G2	graphite satin	+\$0
HF	inner tone light	+\$0
HM	natural maple	+\$0
HP	light anigre	+\$0
HT	inner tone	+\$0
HX	aged cherry	+\$0
HY	walnut on cherry	+\$0
LA	light ash	+\$0
LBA	clear on ash	+\$0
LBB	oak on ash	+\$0
LBC	walnut on ash	+\$0
LBD	dark brown walnut	+\$0
LBR	phantom ecru	+\$0
LBS	phantom cocoa	+\$0
LBU	medium matte walnut	+\$0
LBV	warm grey teak	+\$0
LBE	medium red walnut	+\$0
LBK	pewter mesh	+\$0
LBL	steel mesh	+\$0
LBM	crisp linen	+\$0
LBN	classic linen	+\$0
LBP	casual linen	+\$0
LBF	neutral twill	+\$0
LBG	sarum twill	+\$0
LBH	earthen twill	+\$0
LBJ	graphite twill	+\$0
LBQ	white twill	+\$0
LM	mahogany	+\$0
LU	soft white	+\$0
MT	medium tone	+\$0
SG	slate grey	+\$0
WA	wheat	+\$0
WL	sandstone	+\$0
WN	warm grey neutral	+\$0

Step 12. Cushion Top Fabric

For 1" cushion top (TC1) or 2" cushion top (TC2)

See textiles list for fabric usage and numbers. First 2 digits of number indicate fabric line; remaining digit(s) indicate fabric color.

Price Category 1	+\$0
Price Category 2	+\$68
Price Category 3	+\$82
Price Category 4	+\$101
Price Category 7	+\$137
Price Category 8	+\$321
Price Category 9	+\$950
Price Category B	+\$43
Price Category C	+\$65
Price Category D	+\$75
Price Category E	+\$90
Price Category F	+\$115
Price Category G	+\$151
Price Category H	+\$185
Price Category I	+\$217
Price Category J	+\$250

Step 13. Lock

For no top (NT), 1¹/₄"-high laminate top with thermoplastic edge (TL), 6¹/₂"-high planter top (T7), 6¹/₂"-high full dome, side-to-side (D1), 6¹/₂"-high half dome, sloping left (H1), 6¹/₂"-high half dome, sloping right (H2), or 1¹/₈"-high wood veneer top and wood composite edge with oversail front (TV1)

NL	no lock	-\$30
-----------	---------	-------

For 1"-high painted metal top with squared edge (T1), 1¹/₄"-high painted metal top with squared edge (T2), 1¹/₄"-high painted metal top with radius edge (T3), 1¹/₄"-high recut veneer top (TR), 1¹/₄"-high wood veneer top (TF), 1" cushion top (TC1), or 2" cushion top (TC2)

KA	keyed alike	-\$10
KC	keyed differently, chrome	+\$0
KD	keyed differently, black	+\$0

Bar-Pull Freestanding Lateral File

continued

Step 14. Pull Finish

8Q	folkstone grey	+\$0
91	white	+\$0
98	studio white	+\$0
G1	graphite <input type="checkbox"/> A	+\$0
WL	sandstone <input type="checkbox"/> A	+\$0
CN	metallic champagne <input type="checkbox"/> A	+\$0
MS	metallic silver	+\$0
79	green apple <input type="checkbox"/> A	+\$10
MY3	yellow oxide <input type="checkbox"/> A	+\$10
RO	red <input type="checkbox"/> A	+\$10
TRQ	turquoise <input type="checkbox"/> A	+\$10

Step 15. Base Height

B1	1"-high base	+\$0
B2	1½"-high base	+\$0
B3	2¼"-high base	+\$0
B4	3¼"-high base	+\$0
BA	1"-high recessed base	+\$34
BB	1½"-high recessed base	+\$34
BC	2¼"-high recessed base	+\$34
BD	3¼"-high recessed base	+\$34
B5	4¼"-high base	+\$34
LB2	1½" leg base	+\$34

Step 16. Leg

For 1½" leg base (LB2)

DD	2"-high canvas leg	+\$125
-----------	--------------------	--------

Step 17. Leg Finish

91	white	+\$0
98	studio white	+\$0
CL	cool grey neutral	+\$0
G1	graphite	+\$0
WN	warm grey neutral	+\$0

Metallic Paint

CN	metallic champagne	+\$0
EH	metallic bronze	+\$0
MS	metallic silver	+\$0

Step 18. Counterweight

NO	no counterweight (must gang or anchor)	+\$0
CB	counterweight (recommended)	+\$122

Step 19. Drawer Interior

9P	front-to-back filing rail	+\$0
9R	side-to-side filing rail	+\$0
9M	3 dividers	+\$0

Bevel-Pull Freestanding Lateral File

24-30
24-36
24-42

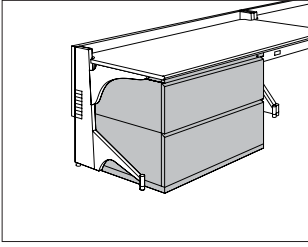

Product Information

Description

This lateral file holds letter-, legal-, and A4-size hanging files. It has bevel pulls and smooth or textured steel. The file has no top or a metal, cushion, laminate, planter, or veneer top. A positive interlock system permits only 1 drawer to open at a time. 1 lock controls all drawers. The drawers can be specified with 3 dividers or with front-to-back or side-to-side filing rails for hanging files. 5 base heights are available; all bases include adjustable glides.

Actual lateral file widths are 29⁷/₈" , 35⁷/₈" , or 41⁷/₈" ; actual depths are 17⁷/₈" or 19⁷/₈" .

Notes

For 2- or 3-high files that are not ganged or anchored, counterweights (option CB) are required. For 4- or 5-high files that are not ganged or anchored, counterweights are recommended.

Dimensional illustrations do not include all possible configurations.

To convert filing direction, order 1 of the following products separately:

- Front-to-back rail (gPxxxx)
- Side-to-side rail (gRxxxx)

See Stackable Lateral File Accessories for specific product number.

Order optional file drawer organizer (LG901) separately.

For work surface on top of 1 or more lateral files, order file top (TPL or TPV) separately.

No lock option (NL) can only be specified on files with no top (NT), dome tops (D1, H1, or H2), planter top (T7), laminate tops (TL), or veneer top (TV1).

For cushion tops TC1 and TC2, a 1" metal top is included.

Cushion top accepts Customer's Own Material (COM). Yardage is estimated for nondirectional, 54"-wide fabrics. When ordering more than 1 cushion, round up total yardage requirement to next whole yard of fabric.

Width—Yardage

30" —1.05

36" —1.22

42" —1.40

For information on multiple quantities or directional fabrics, contact COM Department. See Order Information in Appendices.

For keyed-alike locks, order lock plugs separately. See Keyed-Alike Information in Appendices.

Dimensions

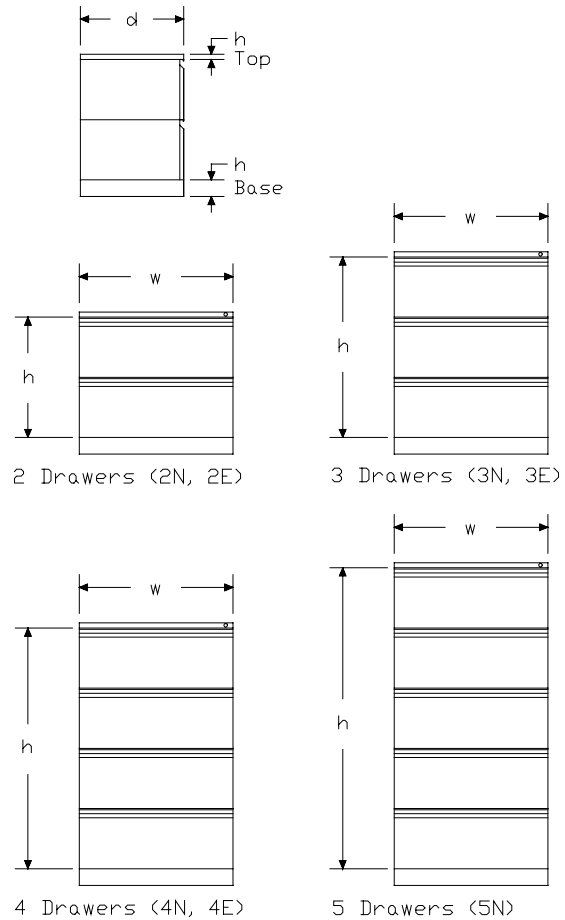

h	N	E
2	23 1/2	26 1/4
3	35 1/4	39 3/8
4	47	52 1/2
5	58 3/4	-

All dimensions are in inches.

Bevel-Pull Freestanding Lateral File *continued*

Specification Information

Step 1.

24-

Step 2. Width

30 30" wide
36 36" wide
42 42" wide

Step 3. Depth

18- 18" deep
20- 20" deep

Step 4. Configuration

2N 2 11³/₄"-high drawers
3N 3 11³/₄"-high drawers
4N 4 11³/₄"-high drawers
5N 5 11³/₄"-high drawers
2E 2 13¹/₈"-high drawers
3E 3 13¹/₈"-high drawers
4E 4 13¹/₈"-high drawers

Prices for Steps 1-4.

		2N	3N	4N	5N	2E	3E
24-30	18-	\$819	1138	1459	1779	819	1138
	20-	\$819	1138	1459	1779	819	1138
24-36	18-	\$907	1257	1608	1958	907	1257
	20-	\$907	1257	1608	1958	907	1257
24-42	18-	\$1029	1422	1817	2214	1029	1422
	20-	\$1029	1422	1817	2214	1029	1422
							4E
24-30	18-						\$1459
	20-						\$1459
24-36	18-						\$1608
	20-						\$1608
24-42	18-						\$1817
	20-						\$1817

Step 5. Paint/Steel Type

SS smooth paint on smooth steel +\$0
TS smooth paint on textured steel +\$35
XS textured paint on smooth steel +\$0

Step 6. Surface Finish

Nonmetallic Paint

For smooth paint on smooth steel (SS) or smooth paint on textured steel (TS)

8Q	folkstone grey	+\$0
91	white	+\$0
98	studio white A	+\$0
9J	sparrow	+\$0
BU	black umber	+\$0
G2	graphite satin	+\$0
HF	inner tone light	+\$0
HT	inner tone	+\$0
LT	light tone	+\$0
LU	soft white	+\$0
MT	medium tone	+\$0
SG	slate grey	+\$0
WA	wheat	+\$0
WL	sandstone	+\$0

Metallic Paint

For smooth paint on smooth steel (SS) or smooth paint on textured steel (TS)

1209	platinum	+\$0
1210	hematite	+\$0
1212	bronzite	+\$0
CN	metallic champagne	+\$0
EH	metallic bronze	+\$0
MS	metallic silver	+\$0

Sand Texture Paint

For textured paint on smooth steel (XS)

98	studio white	+\$0
-----------	--------------	------

Bright Sand Texture Paint

For textured paint on smooth steel (XS)

91	white	+\$0
CL	cool grey neutral	+\$0
G1	graphite	+\$0
WN	warm grey neutral	+\$0

Bevel-Pull Freestanding Lateral

File *continued*

Step 7. Top		
NT	no top	+\$0
T1	1"-high painted metal top with squared edge	+\$0
T2	1¼"-high painted metal top with squared edge	+\$0
T3	1¼"-high painted metal top with radius edge	+\$65
TL	1¼"-high laminate top with thermoplastic edge	+\$74
TR	1¼"-high recut veneer top <input type="checkbox"/> A	+\$150
TF	1¼"-high wood veneer top <input type="checkbox"/> A	+\$156
T7	6½"-high planter top	+\$200
D1	6½"-high full dome, side-to-side	+\$273
H1	6½"-high half dome, sloping left	+\$273
H2	6½"-high half dome, sloping right	+\$273
TV1	1⅛"-high wood veneer top and wood composite edge with oversail front <input type="checkbox"/> A	+\$321
TC1	1" cushion top	+\$394
TC2	2" cushion top	+\$394

Step 8. Lock		
<i>For no top (NT), 1¼"-high laminate top with thermoplastic edge (TL), 6½"-high planter top (T7), 6½"-high full dome, side-to-side (D1), 6½"-high half dome, sloping left (H1), 6½"-high half dome, sloping right (H2), or 1⅛"-high wood veneer top and wood composite edge with oversail front (TV1)</i>		
NL	no lock	-\$30
<i>For 1"-high painted metal top with squared edge (T1), 1¼"-high painted metal top with squared edge (T2), 1¼"-high painted metal top with radius edge (T3), 1¼"-high recut veneer top (TR), 1¼"-high wood veneer top (TF), 1" cushion top (TC1), or 2" cushion top (TC2)</i>		
KA	keyed alike	-\$10
KC	keyed differently, chrome	+\$0
KD	keyed differently, black	+\$0

Step 9.		
Veneer Top Finish: Wood Veneer		
<i>For 1¼"-high wood veneer top (TF)</i>		
2U	light brown walnut <input type="checkbox"/> A	+\$28
40	dark brown walnut <input type="checkbox"/> A	+\$28
ED	aged cherry <input type="checkbox"/> A	+\$28
EK	medium red walnut <input type="checkbox"/> A	+\$28
EW	medium matte walnut <input type="checkbox"/> A	+\$28
ET	clear on ash <input type="checkbox"/> A	+\$28
EU	oak on ash <input type="checkbox"/> A	+\$28
EV	walnut on ash <input type="checkbox"/> A	+\$28
UL	natural maple <input type="checkbox"/> A	+\$28
UX	walnut on cherry <input type="checkbox"/> A	+\$28

Veneer Top Finish: Wood Veneer		
<i>For 1⅛"-high wood veneer top and wood composite edge with oversail front (TV1)</i>		
40	dark brown walnut <input type="checkbox"/> A	+\$28
ED	aged cherry <input type="checkbox"/> A	+\$28
EK	medium red walnut <input type="checkbox"/> A	+\$28
EW	medium matte walnut <input type="checkbox"/> A	+\$28
ET	clear on ash <input type="checkbox"/> A	+\$28
EU	oak on ash <input type="checkbox"/> A	+\$28
EV	walnut on ash <input type="checkbox"/> A	+\$28
UL	natural maple <input type="checkbox"/> A	+\$28
UX	walnut on cherry <input type="checkbox"/> A	+\$28

Veneer Top Finish: Recut Veneer		
<i>For 1¼"-high recut veneer top (TR)</i>		
RA	light ash <input type="checkbox"/> A	+\$0
RK	mahogany dark <input type="checkbox"/> A	+\$0
RM	mahogany <input type="checkbox"/> A	+\$0

Top Finish: Solid-Color Laminate		
<i>For 1¼"-high laminate top with thermoplastic edge (TL)</i>		
8Q	folkstone grey	+\$0
91	white	+\$0
98	studio white	+\$0
CL	cool grey neutral	+\$0
HF	inner tone light	+\$0
HT	inner tone	+\$0
LT	light tone	+\$0
LU	soft white	+\$0
WL	sandstone	+\$0
WN	warm grey neutral	+\$0

Bevel-Pull Freestanding Lateral File *continued*

Top Finish: Linen Laminate

For 1 1/4"-high laminate top with thermoplastic edge (TL)

LBM	crisp linen	+\$0
LBN	classic linen	+\$0
LBP	casual linen	+\$0

Top Finish: Mesh Laminate

For 1 1/4"-high laminate top with thermoplastic edge (TL)

LBK	pewter mesh	+\$0
LBL	steel mesh	+\$0

Top Finish: Twill Laminate

For 1 1/4"-high laminate top with thermoplastic edge (TL)

LBF	neutral twill	+\$0
LBG	sarum twill	+\$0
LBH	earthen twill	+\$0
LBJ	graphite twill	+\$0
LBQ	white twill	+\$0

Top Finish: Wood-Grain Laminate

For 1 1/4"-high laminate top with thermoplastic edge (TL)

HM	natural maple	+\$0
HP	light anigre	+\$0
LA	light ash	+\$0
LBA	clear on ash	+\$0
LBB	oak on ash	+\$0
LBC	walnut on ash	+\$0
LBD	dark brown walnut	+\$0
LBR	phantom ecru	+\$0
LBS	phantom cocoa	+\$0
LBU	medium matte walnut	+\$0
LBV	warm grey teak	+\$0
LBE	medium red walnut	+\$0
LM	mahogany	+\$0
76	light brown walnut	+\$0
HX	aged cherry	+\$0
HY	walnut on cherry	+\$0

Top Finish: Zephyr Laminate

For 1 1/4"-high laminate top with thermoplastic edge (TL)

28	canyon	+\$0
29	misted	+\$0

Step 10. Edge Finish

For 1 1/4"-high laminate top with thermoplastic edge (TL)

28	canyon	+\$0
29	misted	+\$0

76	light brown walnut	+\$0
8Q	folkstone grey	+\$0
91	white	+\$0
98	studio white	+\$0
BU	black umber	+\$0
CL	cool grey neutral	+\$0
G2	graphite satin	+\$0
HF	inner tone light	+\$0
HM	natural maple	+\$0
HP	light anigre	+\$0
HT	inner tone	+\$0
HX	aged cherry	+\$0
HY	walnut on cherry	+\$0
LA	light ash	+\$0
LBA	clear on ash	+\$0
LBB	oak on ash	+\$0
LBC	walnut on ash	+\$0
LBD	dark brown walnut	+\$0
LBR	phantom ecru	+\$0
LBS	phantom cocoa	+\$0
LBU	medium matte walnut	+\$0
LBV	warm grey teak	+\$0
LBE	medium red walnut	+\$0
LBK	pewter mesh	+\$0
LBL	steel mesh	+\$0
LBM	crisp linen	+\$0
LBN	classic linen	+\$0
LBP	casual linen	+\$0
LBF	neutral twill	+\$0
LBG	sarum twill	+\$0
LBH	earthen twill	+\$0
LBJ	graphite twill	+\$0
LBQ	white twill	+\$0
LM	mahogany	+\$0
LU	soft white	+\$0
MT	medium tone	+\$0
SG	slate grey	+\$0
WA	wheat	+\$0
WL	sandstone	+\$0
WN	warm grey neutral	+\$0

Bevel-Pull Freestanding Lateral

File *continued*

Meridian® Freestanding Stackable™ Lateral Files

Step 11. Cushion Top Fabric

*For 1" cushion top (TC1) or 2" cushion top (TC2)
See textiles list for fabric numbers. First 2 digits of number indicate fabric line; remaining digit(s) indicate fabric color.*

Price Category 1	+\$0
Price Category 2	+\$68
Price Category 3	+\$82
Price Category 4	+\$101
Price Category 5	+\$120
Price Category 7 A	+\$137
Price Category 9	+\$950
Price Category (Geiger) 10	+\$1050
Price Category B	+\$47
Price Category C	+\$65
Price Category D	+\$82
Price Category E	+\$99
Price Category F	+\$141
Price Category G	+\$166
Price Category H	+\$204
Price Category I	+\$264
Price Category J	+\$276
Price Category K	+\$310

Step 12. Base Height

B1	1"-high base	+\$0
B2	1½"-high base	+\$0
B3	2¼"-high base	+\$0
B4	3¼"-high base	+\$0
BA	1"-high recessed base	+\$34
BB	1½"-high recessed base	+\$34
BC	2¼"-high recessed base	+\$34
BD	3¼"-high recessed base	+\$34
B5	4¼"-high base	+\$34

Step 13. Counterweight

NO	no counterweight (must gang or anchor)	+\$0
CB	counterweight (recommended)	+\$122

Step 14. Drawer Interior

9P	front-to-back filing rail	+\$0
9R	side-to-side filing rail	+\$0
9M	3 dividers	+\$0

Ellipse-Pull Freestanding Lateral File

2J-30
2J-36
2J-42

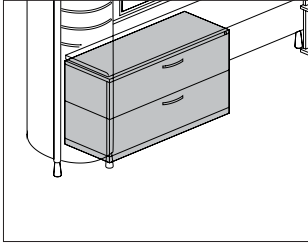

Product Information

Description

This lateral file holds letter-, legal-, and A4-size hanging files. It has ellipse pulls and smooth steel. The file has no top or a metal, cushion, laminate, planter, or veneer top. A positive interlock system permits only 1 drawer to open at a time. 1 lock controls all drawers. The drawers can be specified with 3 dividers or with front-to-back or side-to-side filing rails for hanging files. 5 base heights are available; all bases include adjustable glides.

Actual lateral file widths are 29⁷/₈" , 35⁷/₈" , or 41⁷/₈" ; actual depths are 17⁷/₈" or 19⁷/₈" .

Notes

For 2- or 3-high files that are not ganged or anchored, counterweights (option CB) are required. For 4- or 5-high files that are not ganged or anchored, counterweights are recommended.

Dimensional illustrations do not include all possible configurations.

To convert filing direction, order 1 of the following products separately:

- Front-to-back rail (9Pxxxx)
- Side-to-side rail (9Rxxxxx)

See Stackable Lateral File Accessories for specific product number.

Order optional file drawer organizer (LG901) separately.

For work surface on top of 1 or more lateral files, order file top (TPL or TPV) separately.

No lock option (NL) can only be specified on files with no top (NT), dome tops (D1, H1, or H2), planter top (T7), or laminate tops (TL). The (NL) option cannot be specified for configurations 4W and 4Z; these configurations always have a lock.

For configurations 4W and 4Z, a 1" filler top is included between the overhead storage and the drawers.

For cushion tops TC1 and TC2, a 1" metal top is included.

Cushion top accepts Customer's Own Material (COM). Yardage is estimated for nondirectional, 54"-wide fabrics. When ordering more than 1 cushion, round up total yardage requirement to next whole yard of fabric.

Width—Yardage

30" —1.05

36" —1.22

42" —1.40

For information on multiple quantities or directional fabrics, contact COM Department. See Order Information in Appendices.

For keyed-alike locks, order lock plugs separately. See Keyed-Alike Information in Appendices.

Dimensions

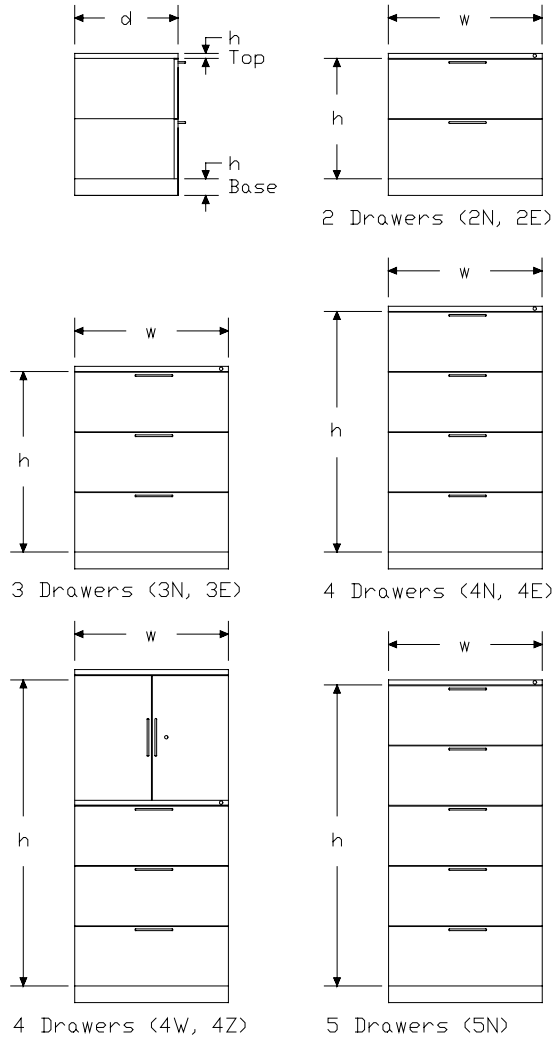

h	N	E	W	Z
2	23 1/2	26 1/4	-	-
3	35 1/4	39 3/8	-	-
4	47	52 1/2	62 1/2	66 5/8
5	58 3/4	-	-	-

All dimensions are in inches.

Ellipse-Pull Freestanding Lateral

File *continued*

Specification Information	
Step 1.	
2J-	<input type="checkbox"/> A
Step 2. Width	
30	30" wide <input type="checkbox"/> A
36	36" wide <input type="checkbox"/> A
42	42" wide <input type="checkbox"/> A
Step 3. Depth	
18-	18" deep <input type="checkbox"/> A
20-	20" deep <input type="checkbox"/> A
Step 4. Configuration	
2N	2 11 ³ / ₄ "-high drawers <input type="checkbox"/> A
3N	3 11 ³ / ₄ "-high drawers <input type="checkbox"/> A
4N	4 11 ³ / ₄ "-high drawers <input type="checkbox"/> A
4W	1 26 ¹ / ₄ "-high overhead storage, 3 11 ³ / ₄ "-high drawers <input type="checkbox"/> A
5N	5 11 ³ / ₄ "-high drawers <input type="checkbox"/> A
2E	2 13 ¹ / ₈ "-high drawers <input type="checkbox"/> A
3E	3 13 ¹ / ₈ "-high drawers <input type="checkbox"/> A
4E	4 13 ¹ / ₈ "-high drawers <input type="checkbox"/> A
4Z	1 26 ¹ / ₄ "-high overhead storage, 3 13 ¹ / ₈ "-high drawers <input type="checkbox"/> A

Prices for Steps 1-4.							
		2N	3N	4N	4W	5N	2E
2J-30	18-	\$896	1252	1605	1980	1957	896
	20-	\$896	1252	1605	1980	1957	896
2J-36	18-	\$998	1383	1768	2210	2154	998
	20-	\$998	1383	1768	2210	2154	998
2J-42	18-	\$1130	1563	1999	2501	2436	1130
	20-	\$1130	1563	1999	2501	2436	1130
				3E	4E	4Z	
2J-30	18-			\$1252	1605	1980	
	20-			\$1252	1605	1980	
2J-36	18-			\$1383	1768	2210	
	20-			\$1383	1768	2210	
2J-42	18-			\$1563	1999	2501	
	20-			\$1563	1999	2501	

Step 5. Paint/Steel Type		
SS	smooth paint on smooth steel <input type="checkbox"/> A	+\$0
TS	smooth paint on textured steel <input type="checkbox"/> A	+\$35
XS	textured paint on smooth steel <input type="checkbox"/> A	+\$0

Step 6. Case Finish		
Nonmetallic Paint		
<i>For smooth paint on smooth steel (SS) or smooth paint on textured steel (TS)</i>		
8Q	folkstone grey <input type="checkbox"/> A	+\$0
91	white <input type="checkbox"/> A	+\$0
98	studio white <input type="checkbox"/> A	+\$0
9J	sparrow <input type="checkbox"/> A	+\$0
BU	black umber <input type="checkbox"/> A	+\$0
G2	graphite satin <input type="checkbox"/> A	+\$0
HF	inner tone light <input type="checkbox"/> A	+\$0
HT	inner tone <input type="checkbox"/> A	+\$0
LT	light tone <input type="checkbox"/> A	+\$0
LU	soft white <input type="checkbox"/> A	+\$0
MT	medium tone <input type="checkbox"/> A	+\$0
SG	slate grey <input type="checkbox"/> A	+\$0
WA	wheat <input type="checkbox"/> A	+\$0
WL	sandstone <input type="checkbox"/> A	+\$0

Metallic Paint		
<i>For smooth paint on smooth steel (SS) or smooth paint on textured steel (TS)</i>		
1209	platinum <input type="checkbox"/> A	+\$0
1210	hematite <input type="checkbox"/> A	+\$0
1212	bronzite <input type="checkbox"/> A	+\$0
CN	metallic champagne <input type="checkbox"/> A	+\$0
EH	metallic bronze <input type="checkbox"/> A	+\$0
MS	metallic silver <input type="checkbox"/> A	+\$0

Sand Texture Paint		
<i>For textured paint on smooth steel (XS)</i>		
98	studio white <input type="checkbox"/> A	+\$0

Bright Sand Texture Paint		
<i>For textured paint on smooth steel (XS)</i>		
91	white <input type="checkbox"/> A	+\$0
CL	cool grey neutral <input type="checkbox"/> A	+\$0
G1	graphite <input type="checkbox"/> A	+\$0
WN	warm grey neutral <input type="checkbox"/> A	+\$0

Ellipse-Pull Freestanding Lateral File *continued*

Step 7. Front Finish

Nonmetallic Paint

For smooth paint on smooth steel (SS) or smooth paint on textured steel (TS)

8Q	folkstone grey <input type="checkbox"/>	+\$0
91	white <input type="checkbox"/>	+\$0
98	studio white <input type="checkbox"/>	+\$0
9J	sparrow <input type="checkbox"/>	+\$0
BU	black umber <input type="checkbox"/>	+\$0
G2	graphite satin <input type="checkbox"/>	+\$0
HF	inner tone light <input type="checkbox"/>	+\$0
HT	inner tone <input type="checkbox"/>	+\$0
LT	light tone <input type="checkbox"/>	+\$0
LU	soft white <input type="checkbox"/>	+\$0
MT	medium tone <input type="checkbox"/>	+\$0
SG	slate grey <input type="checkbox"/>	+\$0
WA	wheat <input type="checkbox"/>	+\$0
WL	sandstone <input type="checkbox"/>	+\$0

Metallic Paint

For smooth paint on smooth steel (SS) or smooth paint on textured steel (TS)

1209	platinum <input type="checkbox"/>	+\$0
1210	hematite <input type="checkbox"/>	+\$0
1212	bronzite <input type="checkbox"/>	+\$0
CN	metallic champagne <input type="checkbox"/>	+\$0
EH	metallic bronze <input type="checkbox"/>	+\$0
MS	metallic silver <input type="checkbox"/>	+\$0

Sand Texture Paint

For textured paint on smooth steel (XS)

98	studio white <input type="checkbox"/>	+\$0
-----------	---------------------------------------	------

Bright Sand Texture Paint

For textured paint on smooth steel (XS)

91	white <input type="checkbox"/>	+\$0
CL	cool grey neutral <input type="checkbox"/>	+\$0
G1	graphite <input type="checkbox"/>	+\$0
WN	warm grey neutral <input type="checkbox"/>	+\$0

Step 8. Top

NT	no top <input type="checkbox"/>	+\$0
T1	1"-high painted metal top with squared edge <input type="checkbox"/>	+\$0
T2	1 ¹ / ₄ "-high painted metal top with squared edge <input type="checkbox"/>	+\$0
T3	1 ¹ / ₄ "-high painted metal top with radius edge <input type="checkbox"/>	+\$65
TL	1 ¹ / ₄ "-high laminate top with thermoplastic edge <input type="checkbox"/>	+\$74
TR	1 ¹ / ₄ "-high recut veneer top <input type="checkbox"/>	+\$150
TF	1 ¹ / ₄ "-high wood veneer top <input type="checkbox"/>	+\$156
T7	6 ¹ / ₂ "-high planter top <input type="checkbox"/>	+\$200
D1	6 ¹ / ₂ "-high full dome, side-to-side <input type="checkbox"/>	+\$273
H1	6 ¹ / ₂ "-high half dome, sloping left <input type="checkbox"/>	+\$273
H2	6 ¹ / ₂ "-high half dome, sloping right <input type="checkbox"/>	+\$273
TV1	1 ¹ / ₈ "-high wood veneer top and wood composite edge with oversail front <input type="checkbox"/>	+\$321
TC1	1" cushion top <input type="checkbox"/>	+\$394
TC2	2" cushion top <input type="checkbox"/>	+\$394

Step 9. Lock

KA	keyed alike <input type="checkbox"/>	-\$10
KC	keyed differently, chrome <input type="checkbox"/>	+\$0
KD	keyed differently, black <input type="checkbox"/>	+\$0

For 2 1³/₄"-high drawers (2N), 3 1³/₄"-high drawers (3N), 4 1³/₄"-high drawers (4N), 5 1³/₄"-high drawers (5N), 2 1³/₈"-high drawers (2E), 3 1³/₈"-high drawers (3E), or 4 1³/₈"-high drawers (4E) with no top (NT), or 1¹/₄"-high laminate top with thermoplastic edge (TL), or 6¹/₂"-high planter top (T7), or 6¹/₂"-high full dome, side-to-side (D1), or 6¹/₂"-high half dome, sloping left (H1), or 6¹/₂"-high half dome, sloping right (H2), or 1¹/₈"-high wood veneer top and wood composite edge with oversail front (TV1)

NL	no lock <input type="checkbox"/>	-\$30
-----------	----------------------------------	-------

Step 10.

Veneer Top Finish: Wood Veneer

For 1¹/₄"-high wood veneer top (TF)

2U	light brown walnut <input type="checkbox"/>	+\$28
40	dark brown walnut <input type="checkbox"/>	+\$28
ED	aged cherry <input type="checkbox"/>	+\$28
EK	medium red walnut <input type="checkbox"/>	+\$28
EW	medium matte walnut <input type="checkbox"/>	+\$28
ET	clear on ash <input type="checkbox"/>	+\$28
EU	oak on ash <input type="checkbox"/>	+\$28
EV	walnut on ash <input type="checkbox"/>	+\$28
UL	natural maple <input type="checkbox"/>	+\$28
UX	walnut on cherry <input type="checkbox"/>	+\$28

Ellipse-Pull Freestanding Lateral

File *continued*

Meridian® Freestanding Stackable™ Lateral Files

Top Finish: Solid-Color Laminate		
<i>For 1 1/4"-high laminate top with thermoplastic edge (TL)</i>		
8Q	folkstone grey <input type="checkbox"/> <input type="checkbox"/>	+\$0
91	white <input type="checkbox"/>	+\$0
98	studio white	+\$0
CL	cool grey neutral <input type="checkbox"/>	+\$0
HF	inner tone light <input type="checkbox"/>	+\$0
HT	inner tone <input type="checkbox"/>	+\$0
LT	light tone <input type="checkbox"/>	+\$0
LU	soft white <input type="checkbox"/>	+\$0
WL	sandstone <input type="checkbox"/>	+\$0
WN	warm grey neutral <input type="checkbox"/>	+\$0

Top Finish: Linen Laminate		
<i>For 1 1/4"-high laminate top with thermoplastic edge (TL)</i>		
LBM	crisp linen	+\$0
LBN	classic linen	+\$0
LBP	casual linen	+\$0

Top Finish: Mesh Laminate		
<i>For 1 1/4"-high laminate top with thermoplastic edge (TL)</i>		
LBK	pewter mesh	+\$0
LBL	steel mesh	+\$0

Top Finish: Twill Laminate		
<i>For 1 1/4"-high laminate top with thermoplastic edge (TL)</i>		
LBF	neutral twill	+\$0
LBG	sarum twill	+\$0
LBH	earthen twill	+\$0
LBJ	graphite twill	+\$0
LBQ	white twill	+\$0

Top Finish: Wood-Grain Laminate		
<i>For 1 1/4"-high laminate top with thermoplastic edge (TL)</i>		
HM	natural maple <input type="checkbox"/>	+\$0
HP	light anigre <input type="checkbox"/>	+\$0
LA	light ash <input type="checkbox"/>	+\$0
LBA	clear on ash	+\$0
LBB	oak on ash	+\$0
LBC	walnut on ash	+\$0
LBD	dark brown walnut	+\$0
LBR	phantom ecru	+\$0
LBS	phantom cocoa	+\$0
LBU	medium matte walnut	+\$0
LBV	warm grey teak	+\$0
LBE	medium red walnut	+\$0
LM	mahogany <input type="checkbox"/>	+\$0
76	light brown walnut <input type="checkbox"/>	+\$0
HX	aged cherry <input type="checkbox"/>	+\$0
HY	walnut on cherry <input type="checkbox"/>	+\$0

Top Finish: Zephyr Laminate		
<i>For 1 1/4"-high laminate top with thermoplastic edge (TL)</i>		
28	canyon <input type="checkbox"/>	+\$0
29	misted <input type="checkbox"/>	+\$0

Veneer Top Finish: Recut Veneer		
<i>For 1 1/4"-high recut veneer top (TR)</i>		
RA	light ash <input type="checkbox"/>	+\$0
RK	mahogany dark <input type="checkbox"/>	+\$0
RM	mahogany <input type="checkbox"/>	+\$0

Veneer Top Finish: Wood Veneer		
<i>For 1 1/8"-high wood veneer top and wood composite edge with oversail front (TV1)</i>		
40	dark brown walnut <input type="checkbox"/>	+\$28
ED	aged cherry <input type="checkbox"/>	+\$28
EK	medium red walnut <input type="checkbox"/>	+\$28
EW	medium matte walnut <input type="checkbox"/>	+\$28
ET	clear on ash <input type="checkbox"/>	+\$28
EU	oak on ash <input type="checkbox"/>	+\$28
EV	walnut on ash <input type="checkbox"/>	+\$28
UL	natural maple <input type="checkbox"/>	+\$28
UX	walnut on cherry <input type="checkbox"/>	+\$28

Step 11. Edge Finish		
<i>For 1 1/4"-high laminate top with thermoplastic edge (TL)</i>		
28	canyon <input type="checkbox"/>	+\$0
29	misted <input type="checkbox"/>	+\$0

Ellipse-Pull Freestanding Lateral File *continued*

76	light brown walnut <input type="checkbox"/>	+\$0
8Q	folkstone grey <input type="checkbox"/>	+\$0
91	white <input type="checkbox"/>	+\$0
98	studio white	+\$0
BU	black umber <input type="checkbox"/>	+\$0
CL	cool grey neutral <input type="checkbox"/>	+\$0
G2	graphite satin <input type="checkbox"/>	+\$0
HF	inner tone light <input type="checkbox"/>	+\$0
HM	natural maple <input type="checkbox"/>	+\$0
HP	light anigre <input type="checkbox"/>	+\$0
HT	inner tone <input type="checkbox"/>	+\$0
HX	aged cherry <input type="checkbox"/>	+\$0
HY	walnut on cherry <input type="checkbox"/>	+\$0
LA	light ash <input type="checkbox"/>	+\$0
LBA	clear on ash	+\$0
LBB	oak on ash	+\$0
LBC	walnut on ash	+\$0
LBD	dark brown walnut	+\$0
LBR	phantom ecru	+\$0
LBS	phantom cocoa	+\$0
LBU	medium matte walnut	+\$0
LBV	warm grey teak	+\$0
LBE	medium red walnut	+\$0
LBK	pewter mesh	+\$0
LBL	steel mesh	+\$0
LBM	crisp linen	+\$0
LBN	classic linen	+\$0
LBP	casual linen	+\$0
LBF	neutral twill	+\$0
LBG	sarum twill	+\$0
LBH	earthen twill	+\$0
LBJ	graphite twill	+\$0
LBQ	white twill	+\$0
LM	mahogany <input type="checkbox"/>	+\$0
LU	soft white <input type="checkbox"/>	+\$0
MT	medium tone <input type="checkbox"/>	+\$0
SG	slate grey <input type="checkbox"/>	+\$0
WA	wheat <input type="checkbox"/>	+\$0
WL	sandstone <input type="checkbox"/>	+\$0
WN	warm grey neutral <input type="checkbox"/>	+\$0

Step 12. Cushion Top Fabric

For 1" cushion top (TC1) or 2" cushion top (TC2)

See textiles list for fabric numbers. First 2 digits of number indicate fabric line; remaining digit(s) indicate fabric color.

Price Category 1	+\$0
Price Category 2	+\$68
Price Category 3	+\$82
Price Category 4	+\$101
Price Category 5	+\$120
Price Category 7	+\$137
Price Category 8	+\$725
Price Category 9	+\$950
Price Category (Geiger) 10	+\$1050
Price Category B	+\$47
Price Category C	+\$65
Price Category D	+\$82
Price Category E	+\$99
Price Category F	+\$141
Price Category G	+\$166
Price Category H	+\$204
Price Category I	+\$211
Price Category J	+\$276
Price Category K	+\$310

Step 13. Base Height

B1	1"-high base <input type="checkbox"/>	+\$0
B2	1½"-high base <input type="checkbox"/>	+\$0
B3	2¼"-high base <input type="checkbox"/>	+\$0
B4	3¼"-high base <input type="checkbox"/>	+\$0
BA	1"-high recessed base <input type="checkbox"/>	+\$34
BB	1½"-high recessed base <input type="checkbox"/>	+\$34
BC	2¼"-high recessed base <input type="checkbox"/>	+\$34
BD	3¼"-high recessed base <input type="checkbox"/>	+\$34
B5	4¼"-high base <input type="checkbox"/>	+\$34

Step 14. Counterweight

NO	no counterweight (must gang or anchor) <input type="checkbox"/>	+\$0
CB	counterweight (recommended) <input type="checkbox"/>	+\$122

Step 15. Drawer Interior

9P	front-to-back filing rail <input type="checkbox"/>	+\$0
9R	side-to-side filing rail <input type="checkbox"/>	+\$0
9M	3 dividers <input type="checkbox"/>	+\$0

Ellipse-Pull Freestanding Lateral

File *continued*

Meridian® Freestanding Stackable™ Lateral Files

Step 16. Overhead Interior		
<i>For 1 26¹/₄"-high overhead storage, 3 11³/₄"-high drawers (4W) or 1 26¹/₄"-high overhead storage, 3 13¹/₈"-high drawers (4Z)</i>		
NS0	no interior option <input type="checkbox"/> A	-\$33
NS1	1 shelf total <input type="checkbox"/> A	+\$0
NS2	2 shelves total <input type="checkbox"/> A	+\$33

Sloped-Pull Freestanding Lateral File

29P-3
29P-4
29V-3
29V-4

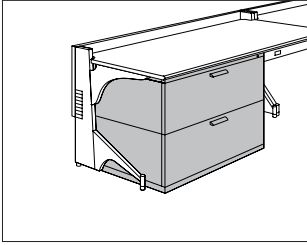

Product Information

Description

This lateral file holds letter-, legal-, and A₄-size hanging files. It has sloped pulls and smooth or textured steel. The file has no top or a metal, cushion, laminate, planter, or veneer top. A positive interlock system permits only 1 drawer to open at a time. 1 lock controls all drawers. The drawers can be specified with 3 dividers or with front-to-back or side-to-side filing rails for hanging files. 5 base heights are available; all bases include adjustable glides.

Actual lateral file widths are 29⁷/₈" , 35⁷/₈" , or 41⁷/₈" ; actual depths are 17⁷/₈" or 19⁷/₈" .

Notes

For 2- or 3-high files that are not ganged or anchored, counterweights (option CB) are required. For 4- or 5-high files that are not ganged or anchored, counterweights are recommended.

Dimensional illustrations do not include all possible configurations.

To convert filing direction, order 1 of the following products separately:

- Front-to-back rail (9Pxxxx)
- Side-to-side rail (9Rxxxx)

See Stackable Lateral File Accessories for specific product number.

Order optional file drawer organizer (LG901) separately.

For work surface on top of 1 or more lateral files, order file top (TPL or TPV) separately.

No lock option (NL) can only be specified on files with no top (NT), dome tops (D1, H1, or H2), planter top (T7), laminate tops (TL), or veneer top (TV1).

For cushion tops TC1 and TC2, a 1" metal top is included.

Grain direction is vertical for veneer-front lateral files.

Cushion top accepts Customer's Own Material (COM). Yardage is estimated for nondirectional, 54"-wide fabrics. When ordering more than 1 cushion, round up total yardage requirement to next whole yard of fabric.

Width—Yardage

30" —1.05

36" —1.22

42" —1.40

For information on multiple quantities or directional fabrics, contact COM Department. See Order Information in Appendices.

For keyed-alike locks, order lock plugs separately. See Keyed-Alike Information in Appendices.

Dimensions

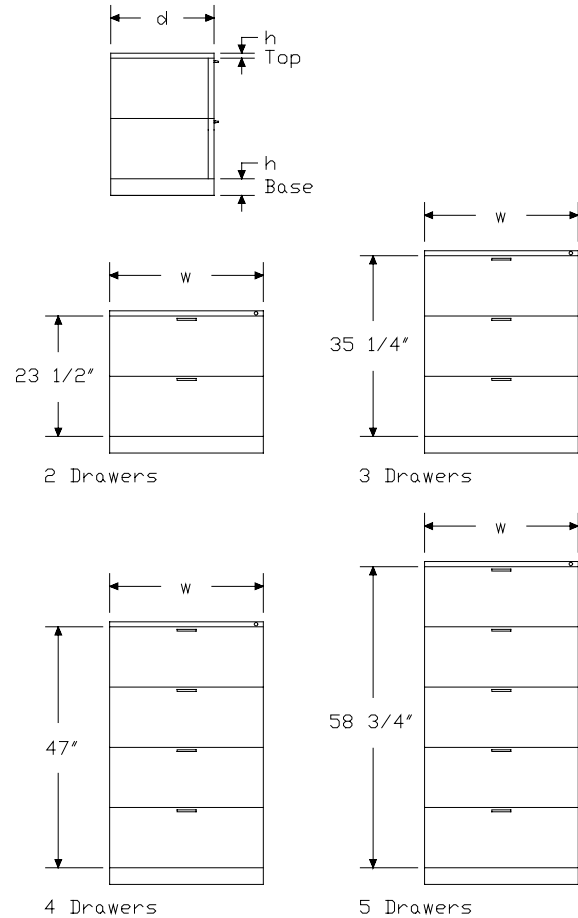

Sloped-Pull Freestanding Lateral

File *continued*

Specification Information					
Step 1.					
29					
Step 2. Front Material					
P-	painted metal front				
V-	veneer front A				
Step 3. Width					
30	30" wide				
36	36" wide				
42	42" wide				
Step 4. Depth					
18-	18" deep				
20-	20" deep				
Step 5. Configuration					
2N	2 drawers				
3N	3 drawers				
4N	4 drawers				
5N	5 drawers				
Prices for Steps 1-5.					
		2N	3N	4N	5N
29P-30	18-	\$900	1252	1605	1958
	20-	\$900	1252	1605	1958
29P-36	18-	\$999	1384	1769	2155
	20-	\$999	1384	1769	2155
29P-42	18-	\$1132	1565	2000	2435
	20-	\$1132	1565	2000	2435
29V-30	18-	\$1267	1806	2340	2881
	20-	\$1267	1806	2340	2881
29V-36	18-	\$1441	2047	2654	3260
	20-	\$1441	2047	2654	3260
29V-42	18-	\$1642	2332	3026	3715
	20-	\$1642	2332	3026	3715
Step 6. Paint/Steel Type					
SS	smooth paint on smooth steel				+\$0
TS	smooth paint on textured steel				+\$35
XS	textured paint on smooth steel				+\$0

Step 7. Surface Finish		
Nonmetallic Paint		
<i>For smooth paint on smooth steel (SS) or smooth paint on textured steel (TS)</i>		
8Q	folkstone grey	+\$0
91	white	+\$0
98	studio white A	+\$0
9J	sparrow	+\$0
BU	black umber	+\$0
G2	graphite satin	+\$0
HF	inner tone light	+\$0
HT	inner tone	+\$0
LT	light tone	+\$0
LU	soft white	+\$0
MT	medium tone	+\$0
SG	slate grey	+\$0
WA	wheat	+\$0
WL	sandstone	+\$0
Metallic Paint		
<i>For smooth paint on smooth steel (SS) or smooth paint on textured steel (TS)</i>		
1209	platinum	+\$0
1210	hematite	+\$0
1212	bronzite	+\$0
CN	metallic champagne	+\$0
EH	metallic bronze	+\$0
MS	metallic silver	+\$0
Sand Texture Paint		
<i>For textured paint on smooth steel (XS)</i>		
98	studio white A	+\$0
Bright Sand Texture Paint		
<i>For textured paint on smooth steel (XS)</i>		
91	white	+\$0
CL	cool grey neutral	+\$0
G1	graphite	+\$0
WN	warm grey neutral	+\$0

Sloped-Pull Freestanding Lateral File *continued*

Step 8. Top

For painted metal front (P-)

NT	no top	+\$0
T1	1"-high painted metal top with squared edge	+\$0
T2	1 1/4"-high painted metal top with squared edge	+\$0
T3	1 1/4"-high painted metal top with radius edge	+\$65
TL	1 1/4"-high laminate top with thermoplastic edge	+\$74
TR	1 1/4"-high recut veneer top A	+\$150
TF	1 1/4"-high wood veneer top A	+\$156
T7	6 1/2"-high planter top	+\$200
D1	6 1/2"-high full dome, side-to-side	+\$273
H1	6 1/2"-high half dome, sloping left	+\$273
H2	6 1/2"-high half dome, sloping right	+\$273
TV1	1 1/8"-high wood veneer top and wood composite edge with oversail front A	+\$321
TC1	1" cushion top	+\$394
TC2	2" cushion top	+\$394

For veneer front (V-)

NT	no top	+\$0
T1	1"-high painted metal top with squared edge	+\$0
T2	1 1/4"-high painted metal top with squared edge	+\$0
T3	1 1/4"-high painted metal top with radius edge	+\$65
TL	1 1/4"-high laminate top with thermoplastic edge	+\$74
TF	1 1/4"-high wood veneer top A	+\$156
T7	6 1/2"-high planter top	+\$200
D1	6 1/2"-high full dome, side-to-side	+\$273
H1	6 1/2"-high half dome, sloping left	+\$273
H2	6 1/2"-high half dome, sloping right	+\$273
TV1	1 1/8"-high wood veneer top and wood composite edge with oversail front A	+\$321
TC1	1" cushion top	+\$394
TC2	2" cushion top	+\$394

Step 9.

Veneer Front Finish: Wood Veneer

For veneer front (V-) with no top (NT), 1"-high painted metal top with squared edge (T1), 1 1/4"-high painted metal top with squared edge (T2), 1 1/4"-high painted metal top with radius edge (T3), 1 1/4"-high laminate top with thermoplastic edge (TL), 6 1/2"-high planter top (T7), 6 1/2"-high full dome, side-to-side (D1), 6 1/2"-high half dome, sloping left (H1), 6 1/2"-high half dome, sloping right (H2), or 1" cushion top (TC1), or 2" cushion top (TC2)

2U	light brown walnut A	+\$56
40	dark brown walnut A	+\$56
ED	aged cherry A	+\$56
EK	medium red walnut A	+\$56
EW	medium matte walnut A	+\$56
ET	clear on ash A	+\$56
EU	oak on ash A	+\$56
EV	walnut on ash A	+\$56
UL	natural maple A	+\$56
UX	walnut on cherry A	+\$56

Veneer Top Finish: Wood Veneer

For painted metal front (P-) with 1 1/4"-high wood veneer top (TF)

2U	light brown walnut A	+\$28
40	dark brown walnut A	+\$28
ED	aged cherry A	+\$28
EK	medium red walnut A	+\$28
EW	medium matte walnut A	+\$28
ET	clear on ash A	+\$28
EU	oak on ash A	+\$28
EV	walnut on ash A	+\$28
UL	natural maple A	+\$28
UX	walnut on cherry A	+\$28

Veneer Front/Top Finish: Wood Veneer

For veneer front (V-) with 1 1/8"-high wood veneer top and wood composite edge with oversail front (TV1)

40	dark brown walnut A	+\$56
ED	aged cherry A	+\$56
EK	medium red walnut A	+\$56
EW	medium matte walnut A	+\$56
ET	clear on ash A	+\$56
EU	oak on ash A	+\$56
EV	walnut on ash A	+\$56
UL	natural maple A	+\$56
UX	walnut on cherry A	+\$56

Sloped-Pull Freestanding Lateral

File *continued*

Meridian® Freestanding Stackable™ Lateral Files

Veneer Top Finish: Wood Veneer
For painted metal front (P-) with 1¹/₈"-high wood veneer top and wood composite edge with oversail front (TV₁)

40	dark brown walnut A	+\$28
ED	aged cherry A	+\$28
EK	medium red walnut A	+\$28
EW	medium matte walnut A	+\$28
ET	clear on ash A	+\$28
EU	oak on ash A	+\$28
EV	walnut on ash A	+\$28
UL	natural maple A	+\$28
UX	walnut on cherry A	+\$28

Veneer Top Finish: Recut Veneer
For painted metal front (P-) with 1¹/₄"-high recut veneer top (TR)

RA	light ash A	+\$0
RK	mahogany dark A	+\$0
RM	mahogany A	+\$0

Veneer Front/Top Finish: Wood Veneer
For veneer front (V-) with 1¹/₄"-high wood veneer top (TF)

2U	light brown walnut A	+\$56
40	dark brown walnut A	+\$56
ED	aged cherry A	+\$56
EK	medium red walnut A	+\$56
EW	medium matte walnut A	+\$56
ET	clear on ash A	+\$56
EU	oak on ash A	+\$56
EV	walnut on ash A	+\$56
UL	natural maple A	+\$56
UX	walnut on cherry A	+\$56

Step 10. Top Finish
For 1¹/₄"-high laminate top with thermoplastic edge (TL)

Solid-Color Laminate

8Q	folkstone grey	+\$0
91	white	+\$0
98	studio white	+\$0
CL	cool grey neutral	+\$0
HF	inner tone light	+\$0
HT	inner tone	+\$0
LT	light tone	+\$0
LU	soft white	+\$0
WL	sandstone	+\$0
WN	warm grey neutral	+\$0

Linen Laminate

LBM	crisp linen	+\$0
LBN	classic linen	+\$0
LBP	casual linen	+\$0

Mesh Laminate

LBK	pewter mesh	+\$0
LBL	steel mesh	+\$0

Twill Laminate

LBF	neutral twill	+\$0
LBG	sarum twill	+\$0
LBH	earthen twill	+\$0
LBJ	graphite twill	+\$0
LBQ	white twill	+\$0

Wood-Grain Laminate

HM	natural maple	+\$0
HP	light anigre	+\$0
LA	light ash	+\$0
LBA	clear on ash	+\$0
LBB	oak on ash	+\$0
LBC	walnut on ash	+\$0
LBD	dark brown walnut	+\$0
LBR	phantom ecru	+\$0
LBS	phantom cocoa	+\$0
LBU	medium matte walnut	+\$0
LBV	warm grey teak	+\$0
LBE	medium red walnut	+\$0
LM	mahogany	+\$0
76	light brown walnut	+\$0
HX	aged cherry	+\$0
HY	walnut on cherry	+\$0

Zephyr Laminate

28	canyon	+\$0
29	misted	+\$0

Step 11. Edge Finish
For 1¹/₄"-high laminate top with thermoplastic edge (TL)

28	canyon	+\$0
29	misted	+\$0
76	light brown walnut	+\$0
8Q	folkstone grey	+\$0
91	white	+\$0
98	studio white	+\$0
BU	black umber	+\$0

Sloped-Pull Freestanding Lateral File *continued*

CL	cool grey neutral	+\$0
G2	graphite satin	+\$0
HF	inner tone light	+\$0
HM	natural maple	+\$0
HP	light anigre	+\$0
HT	inner tone	+\$0
HX	aged cherry	+\$0
HY	walnut on cherry	+\$0
LA	light ash	+\$0
LBA	clear on ash	+\$0
LBB	oak on ash	+\$0
LBC	walnut on ash	+\$0
LBD	dark brown walnut	+\$0
LBR	phantom ecru	+\$0
LBS	phantom cocoa	+\$0
LBU	medium matte walnut	+\$0
LBV	warm grey teak	+\$0
LBE	medium red walnut	+\$0
LBK	pewter mesh	+\$0
LBL	steel mesh	+\$0
LBM	crisp linen	+\$0
LBN	classic linen	+\$0
LBP	casual linen	+\$0
LBF	neutral twill	+\$0
LBG	sarum twill	+\$0
LBH	earthen twill	+\$0
LBJ	graphite twill	+\$0
LBQ	white twill	+\$0
LM	mahogany	+\$0
LU	soft white	+\$0
MT	medium tone	+\$0
SG	slate grey	+\$0
WA	wheat	+\$0
WL	sandstone	+\$0
WN	warm grey neutral	+\$0

Step 12. Cushion Top Fabric

For 1" cushion top (TC1) or 2" cushion top (TC2)

See textiles list for fabric numbers. First 2 digits of number indicate fabric line; remaining digit(s) indicate fabric color.

Price Category 1	+\$0
Price Category 2	+\$68
Price Category 3	+\$82
Price Category 4	+\$101
Price Category 5	+\$120
Price Category 7	+\$137
Price Category 8	+\$725
Price Category 9	+\$950
Price Category (Geiger) 10	+\$1050
Price Category B	+\$47
Price Category C	+\$65
Price Category D	+\$82
Price Category E	+\$99
Price Category F	+\$141
Price Category G	+\$166
Price Category H	+\$204
Price Category I	+\$264
Price Category J	+\$276
Price Category K	+\$310

Step 13. Lock

For no top (NT), 1¹/₄"-high laminate top with thermoplastic edge (TL), 6¹/₂"-high planter top (T7), 6¹/₂"-high full dome, side-to-side (D1), 6¹/₂"-high half dome, sloping left (H1), 6¹/₂"-high half dome, sloping right (H2), or 1¹/₈"-high wood veneer top and wood composite edge with oversail front (TV1)

NL	no lock	-\$30
-----------	---------	-------

For 1"-high painted metal top with squared edge (T1), 1¹/₄"-high painted metal top with squared edge (T2), 1¹/₄"-high painted metal top with radius edge (T3), 1¹/₄"-high recut veneer top (TR), 1¹/₄"-high wood veneer top (TF), 1" cushion top (TC1), or 2" cushion top (TC2)

KA	keyed alike	-\$10
KC	keyed differently, chrome	+\$0
KD	keyed differently, black	+\$0

Step 14. Pull Finish

G2	graphite satin	+\$0
U1	brushed aluminum	+\$0

Sloped-Pull Freestanding Lateral File *continued*

Meridian® Freestanding Stackable™ Lateral Files

Step 15. Base Height		
B1	1"-high base	+\$0
B2	1½"-high base	+\$0
B3	2¼"-high base	+\$0
B4	3¼"-high base	+\$0
BA	1"-high recessed base	+\$34
BB	1½"-high recessed base	+\$34
BC	2¼"-high recessed base	+\$34
BD	3¼"-high recessed base	+\$34
B5	4¼"-high base	+\$34
Step 16. Counterweight		
NO	no counterweight (must gang or anchor)	+\$0
CB	counterweight (recommended)	+\$122
Step 17. Drawer Interior		
9P	front-to-back filing rail	+\$0
9R	side-to-side filing rail	+\$0
9M	3 dividers	+\$0

Retrofit Cushion Top

TC1-3
TC1-4
TC2-3
TC2-4

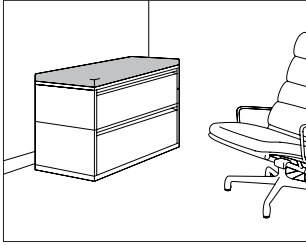

Product Information

Description

This cushion top is retrofit to a lateral file or storage case with a flat metal top. It is available in 2 heights, 3 widths, and 2 depths. Hook-and-loop fastener strips are included to attach cushion to flat metal top.

Notes

Cushion top accepts Customer's Own Material (COM). Yardage is estimated for nondirectional, 54"-wide fabrics. When ordering more than 1 cushion, round up total yardage requirement to next whole yard of fabric.

Width—Yardage

30" — 1.05

36" — 1.22

42" — 1.40

For information on multiple quantities or directional fabrics, contact COM Department. See Order Information in Appendices.

Dimensions

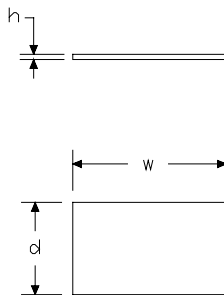

Specification Information

Step 1.

TC

Step 2. Height

1- 1" high

2- 2" high

Step 3. Width

30 30" wide

36 36" wide

42 42" wide

Step 4. Depth

18 18" deep

20 20" deep

Prices for Steps 1-4.

TC1-30	18	\$383
	20	\$383
TC1-36	18	\$383
	20	\$383
TC1-42	18	\$383
	20	\$383
TC2-30	18	\$383
	20	\$383
TC2-36	18	\$383
	20	\$383
TC2-42	18	\$383
	20	\$383

Retrofit Cushion Top *continued*

Step 5. Cushion Top Fabric	
<i>See textiles list for fabric numbers. First 2 digits of number indicate fabric line; remaining digit(s) indicate fabric color.</i>	
Price Category 1	+\$0
Price Category 2	+\$68
Price Category 3	+\$82
Price Category 4	+\$101
Price Category 5	+\$120
Price Category 7	+\$137
Price Category 8	+\$725
Price Category 9	+\$950
Price Category (Geiger) 10	+\$1050
Price Category B	+\$47
Price Category C	+\$43
Price Category D	+\$82
Price Category E	+\$99
Price Category F	+\$54
Price Category G	+\$166
Price Category H	+\$204
Price Category I	+\$100
Price Category J	+\$276
Price Category K	+\$310

Standard-Pull Mobile Lateral File

M26-3
M26-4

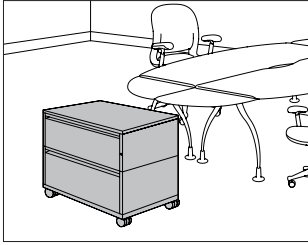

Product Information

Description

This lateral file holds letter-, legal-, and A4-size hanging files. It has standard pulls and smooth or textured steel. The file has a metal, cushion, laminate, planter, or veneer top. A positive interlock system permits only 1 drawer to open at a time. 1 lock controls all drawers. The drawers can be specified with 3 dividers or with front-to-back or side-to-side filing rails for hanging files. The 4³/₄"-high mobile base has a 1¹/₂"-high base frame with 3³/₄"-high outset casters. The 2 swivel and 2 fixed casters must be field installed.

Actual lateral file widths are 29⁷/₈", 35⁷/₈", or 41⁷/₈"; actual depths are 17⁷/₈" or 19⁷/₈".

Notes

Dimensional illustrations do not include all possible configurations. To convert filing direction, order 1 of the following products separately:

- Front-to-back rail (9Pxxxx)
- Side-to-side rail (9Rxxxx)

See Stackable Lateral File Accessories for specific product number. Order optional file drawer organizer (LG901) separately. For cushion tops TC1 and TC2, a 1" metal top is included. Cushion top accepts Customer's Own Material (COM). Yardage is estimated for nondirectional, 54"-wide fabrics. When ordering more than 1 cushion, round up total yardage requirement to next whole yard of fabric.

Width—Yardage

30" —1.05
36" —1.22
42" —1.40

For information on multiple quantities or directional fabrics, contact COM Department. See Order Information in Appendices. For keyed-alike locks, order lock plugs separately. See Keyed-Alike Information in Appendices.

Dimensions

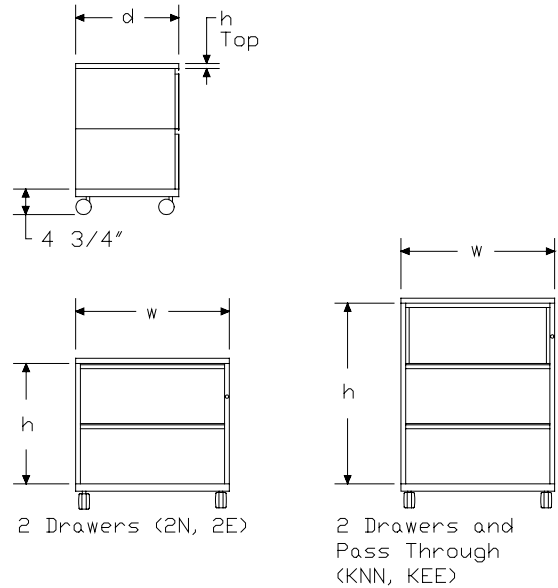

h	N	E	NN	EE
2	23 1/2	26 1/4	-	-
K	-	-	36 5/8	39 3/8

All dimensions are in inches.

Meridian® Mobile Stackable™ Lateral Files

Standard-Pull Mobile Lateral File

continued

Meridian® Mobile Stackable™ Lateral Files

Specification Information

Step 1.

M26-

Step 2. Width

30	30" wide
36	36" wide
42	42" wide

Step 3. Depth

18-	18" deep
20-	20" deep

Step 4. Configuration

2N	2 11 ³ / ₄ "-high drawers
2E	2 13 ¹ / ₈ "-high drawers
KNN	pass-through unit, 2 11 ³ / ₄ "-high drawers
KEE	pass-through unit, 2 13 ¹ / ₈ "-high drawers

Prices for Steps 1-4.

	2N	2E	KNN	KEE
M26-30 18-	\$1173	1173	1509	1509
20-	\$1173	1173	1509	1509
M26-36 18-	\$1277	1277	1636	1636
20-	\$1277	1277	1636	1636
M26-42 18-	\$1404	1404	1810	1810
20-	\$1404	1404	1810	1810

Step 5. Paint/Steel Type

SS	smooth paint on smooth steel	+\$0
TS	smooth paint on textured steel	+\$35
XS	textured paint on smooth steel	+\$0

Step 6. Surface Finish

Nonmetallic Paint

For smooth paint on smooth steel (SS) or smooth paint on textured steel (TS)

8Q	folkstone grey	+\$0
91	white	+\$0
98	studio white A	+\$0
9J	sparrow	+\$0
BU	black umber	+\$0
G2	graphite satin	+\$0
HF	inner tone light	+\$0
HT	inner tone	+\$0
LT	light tone	+\$0
LU	soft white	+\$0
MT	medium tone	+\$0
SG	slate grey	+\$0
WA	wheat	+\$0
WL	sandstone	+\$0

Metallic Paint

For smooth paint on smooth steel (SS) or smooth paint on textured steel (TS)

1209	platinum	+\$0
1210	hematite	+\$0
1212	bronzite	+\$0
CN	metallic champagne	+\$0
EH	metallic bronze	+\$0
MS	metallic silver	+\$0

Sand Texture Paint

For textured paint on smooth steel (XS)

98	studio white A	+\$0
-----------	-----------------------	------

Bright Sand Texture Paint

For textured paint on smooth steel (XS)

91	white	+\$0
CL	cool grey neutral	+\$0
G1	graphite	+\$0
WN	warm grey neutral	+\$0

Standard-Pull Mobile Lateral File

continued

Step 7. Top

T1	1"-high painted metal top with squared edge	+\$0
T2	1 1/4"-high painted metal top with squared edge	+\$0
T3	1 1/4"-high painted metal top with radius edge	+\$65
TL	1 1/4"-high laminate top with thermoplastic edge	+\$74
TR	1 1/4"-high recut veneer top <input type="checkbox"/> A	+\$150
TF	1 1/4"-high wood veneer top <input type="checkbox"/> A	+\$156
T7	6 1/2"-high planter top	+\$200
D1	6 1/2"-high full dome, side-to-side	+\$273
H1	6 1/2"-high half dome, sloping left	+\$273
H2	6 1/2"-high half dome, sloping right	+\$273
TV1	1 1/8"-high wood veneer top and wood composite edge with oversail front <input type="checkbox"/> A	+\$321
TC1	1" cushion top	+\$394
TC2	2" cushion top	+\$394

Step 8.

Veneer Top Finish

For 1 1/4"-high wood veneer top (TF)

2U	light brown walnut <input type="checkbox"/> A	+\$28
40	dark brown walnut <input type="checkbox"/> A	+\$28
ED	aged cherry <input type="checkbox"/> A	+\$28
EK	medium red walnut <input type="checkbox"/> A	+\$28
EW	medium matte walnut <input type="checkbox"/> A	+\$28
ET	clear on ash <input type="checkbox"/> A	+\$28
EU	oak on ash <input type="checkbox"/> A	+\$28
EV	walnut on ash <input type="checkbox"/> A	+\$28
UL	natural maple <input type="checkbox"/> A	+\$28
UX	walnut on cherry <input type="checkbox"/> A	+\$28

Veneer Top Finish

For 1 1/4"-high recut veneer top (TR)

RA	light ash <input type="checkbox"/> A	+\$0
RK	mahogany dark <input type="checkbox"/> A	+\$0
RM	mahogany <input type="checkbox"/> A	+\$0

Top Finish: Solid-Color Laminate

For 1 1/4"-high laminate top with thermoplastic edge (TL)

8Q	folkstone grey	+\$0
91	white	+\$0
98	studio white	+\$0
CL	cool grey neutral	+\$0
HF	inner tone light	+\$0
HT	inner tone	+\$0
LT	light tone	+\$0
LU	soft white	+\$0
WL	sandstone	+\$0
WN	warm grey neutral	+\$0

Top Finish: Linen Laminate

For 1 1/4"-high laminate top with thermoplastic edge (TL)

LBM	crisp linen	+\$0
LBN	classic linen	+\$0
LBP	casual linen	+\$0

Top Finish: Mesh Laminate

For 1 1/4"-high laminate top with thermoplastic edge (TL)

LBK	pewter mesh	+\$0
LBL	steel mesh	+\$0

Top Finish: Twill Laminate

For 1 1/4"-high laminate top with thermoplastic edge (TL)

LBF	neutral twill	+\$0
LBG	sarum twill	+\$0
LBH	earthen twill	+\$0
LBJ	graphite twill	+\$0
LBQ	white twill	+\$0

Meridian® Mobile Stackable™ Lateral Files

Standard-Pull Mobile Lateral File

continued

Meridian® Mobile Stackable™ Lateral Files

Top Finish: Wood-Grain Laminate

For 1 1/4"-high laminate top with thermoplastic edge (TL)

HM	natural maple	+\$0
HP	light anigre	+\$0
LA	light ash	+\$0
LBA	clear on ash	+\$0
LBB	oak on ash	+\$0
LBC	walnut on ash	+\$0
LBD	dark brown walnut	+\$0
LBR	phantom ecru	+\$0
LBS	phantom cocoa	+\$0
LBU	medium matte walnut	+\$0
LBV	warm grey teak	+\$0
LBE	medium red walnut	+\$0
LM	mahogany	+\$0
76	light brown walnut	+\$0
HX	aged cherry	+\$0
HY	walnut on cherry	+\$0

Top Finish: Zephyr Laminate

For 1 1/4"-high laminate top with thermoplastic edge (TL)

28	canyon	+\$0
29	misted	+\$0

Veneer Top Finish

For 1 1/8"-high wood veneer top and wood composite edge with oversail front (TV1)

40	dark brown walnut A	+\$28
ED	aged cherry A	+\$28
EK	medium red walnut A	+\$28
EW	medium matte walnut A	+\$28
ET	clear on ash A	+\$28
EU	oak on ash A	+\$28
EV	walnut on ash A	+\$28
UL	natural maple A	+\$28
UX	walnut on cherry A	+\$28

Step 9. Edge Finish

For 1 1/4"-high laminate top with thermoplastic edge (TL)

28	canyon	+\$0
29	misted	+\$0
76	light brown walnut	+\$0
8Q	folkstone grey	+\$0
91	white	+\$0
98	studio white	+\$0
BU	black umber	+\$0
CL	cool grey neutral	+\$0

G2	graphite satin	+\$0
HF	inner tone light	+\$0
HM	natural maple	+\$0
HP	light anigre	+\$0
HT	inner tone	+\$0
HX	aged cherry	+\$0
HY	walnut on cherry	+\$0
LA	light ash	+\$0
LBA	clear on ash	+\$0
LBB	oak on ash	+\$0
LBC	walnut on ash	+\$0
LBD	dark brown walnut	+\$0
LBR	phantom ecru	+\$0
LBS	phantom cocoa	+\$0
LBU	medium matte walnut	+\$0
LBV	warm grey teak	+\$0
LBE	medium red walnut	+\$0
LBK	pewter mesh	+\$0
LBL	steel mesh	+\$0
LBM	crisp linen	+\$0
LBN	classic linen	+\$0
LBP	casual linen	+\$0
LBF	neutral twill	+\$0
LBG	sarum twill	+\$0
LBH	earthen twill	+\$0
LBJ	graphite twill	+\$0
LBQ	white twill	+\$0
LM	mahogany	+\$0
LU	soft white	+\$0
MT	medium tone	+\$0
SG	slate grey	+\$0
WA	wheat	+\$0
WL	sandstone	+\$0
WN	warm grey neutral	+\$0

Standard-Pull Mobile Lateral File

continued

Step 10. Cushion Top Fabric

For 1" cushion top (TC1) or 2" cushion top (TC2)

See textiles list for fabric numbers. First 2 digits of number indicate fabric line; remaining digit(s) indicate fabric color.

Price Category 1	+\$0
Price Category 2	+\$68
Price Category 3	+\$82
Price Category 4	+\$101
Price Category 5	+\$120
Price Category 7	+\$137
Price Category 8	+\$725
Price Category 9	+\$950
Price Category (Geiger) 10	+\$1050
Price Category B	+\$47
Price Category C	+\$65
Price Category D	+\$82
Price Category E	+\$99
Price Category F	+\$141
Price Category G	+\$166
Price Category H	+\$204
Price Category I	+\$264
Price Category J	+\$276
Price Category K	+\$310

Step 11. Lock

KA	keyed alike	-\$10
KC	keyed differently, chrome	+\$0
KD	keyed differently, black	+\$0

Step 12. Drawer Interior

9M	3 dividers	+\$0
9P	front-to-back filing rail	+\$0
9R	side-to-side filing rail	+\$0

Bevel-Pull Mobile Lateral File

M24-3
M24-4

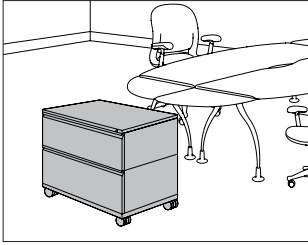

Meridian® Mobile Stackable™ Lateral Files

Product Information

Description

This lateral file holds letter-, legal-, and A4-size hanging files. It has bevel pulls and smooth or textured steel. The file has a metal, cushion, laminate, planter, or veneer top. A positive interlock system permits only 1 drawer to open at a time. 1 lock controls all drawers. The drawers can be specified with 3 dividers or with front-to-back or side-to-side filing rails for hanging files. The 4³/₄"-high mobile base has a 1¹/₂"-high base frame with 3¹/₄"-high outset casters. The 2 swivel and 2 fixed casters must be field installed.

Actual lateral file widths are 29⁷/₈", 35⁷/₈", or 41⁷/₈"; actual depths are 17⁷/₈" or 19⁷/₈".

Notes

Dimensional illustrations do not include all possible configurations.

To convert filing direction, order 1 of the following products separately:

- Front-to-back rail (gPxxxx)
- Side-to-side rail (gRxxxx)

See Stackable Lateral File Accessories for specific product number.

Order optional file drawer organizer (LG901) separately.

For cushion tops TC1 and TC2, a 1" metal top is included.

Cushion top accepts Customer's Own Material (COM). Yardage is estimated for nondirectional, 54"-wide fabrics. When ordering more than 1 cushion, round up total yardage requirement to next whole yard of fabric.

Width—Yardage

30"—1.05

36"—1.22

42"—1.40

For information on multiple quantities or directional fabrics, contact COM Department. See Order Information in Appendices.

For keyed-alike locks, order lock plugs separately. See Keyed-Alike Information in Appendices.

Dimensions

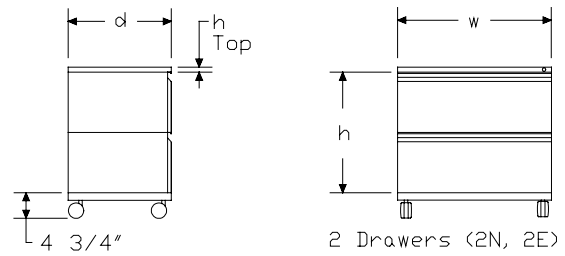

h	N	E
2	23 1/2	26 1/4

All dimensions are in inches.

Bevel-Pull Mobile Lateral File

continued

Specification Information

Step 1.

M24-

Step 2. Width

30	30" wide
36	36" wide
42	42" wide

Step 3. Depth

18-	18" deep
20-	20" deep

Step 4. Configuration

2N	2 11 ³ / ₄ "-high drawers
2E	2 13 ¹ / ₈ "-high drawers

Prices for Steps 1-4.

	2N	2E
M24-30 18-	\$1173	1173
20-	\$1173	1173
M24-36 18-	\$1277	1277
20-	\$1277	1277
M24-42 18-	\$1404	1404
20-	\$1404	1404

Step 5. Paint/Steel Type

SS	smooth paint on smooth steel	+\$0
TS	smooth paint on textured steel	+\$35
XS	textured paint on smooth steel	+\$0

Step 6. Surface Finish

Nonmetallic Paint

For smooth paint on smooth steel (SS) or smooth paint on textured steel (TS)

8Q	folkstone grey	+\$0
91	white	+\$0
98	studio white A	+\$0
9J	sparrow	+\$0
BU	black umber	+\$0
G2	graphite satin	+\$0
HF	inner tone light	+\$0
HT	inner tone	+\$0
LT	light tone	+\$0
LU	soft white	+\$0
MT	medium tone	+\$0
SG	slate grey	+\$0
WA	wheat	+\$0
WL	sandstone	+\$0

Metallic Paint

For smooth paint on smooth steel (SS) or smooth paint on textured steel (TS)

1209	platinum	+\$0
1210	hematite	+\$0
1212	bronzite	+\$0
CN	metallic champagne	+\$0
EH	metallic bronze	+\$0
MS	metallic silver	+\$0

Sand Texture Paint

For textured paint on smooth steel (XS)

98	studio white A	+\$0
-----------	--	------

Bright Sand Texture Paint

For textured paint on smooth steel (XS)

91	white	+\$0
CL	cool grey neutral	+\$0
G1	graphite	+\$0
WN	warm grey neutral	+\$0

Meridian® Mobile Stackable™ Lateral Files

Bevel-Pull Mobile Lateral File

continued

Step 7. Top		
T1	1"-high painted metal top with squared edge	+\$0
T2	1 1/4"-high painted metal top with squared edge	+\$0
T3	1 1/4"-high painted metal top with radius edge	+\$65
TL	1 1/4"-high laminate top with thermoplastic edge	+\$74
TR	1 1/4"-high recut veneer top A	+\$150
TF	1 1/4"-high wood veneer top A	+\$156
T7	6 1/2"-high planter top	+\$200
D1	6 1/2"-high full dome, side-to-side	+\$273
H1	6 1/2"-high half dome, sloping left	+\$273
H2	6 1/2"-high half dome, sloping right	+\$273
TV1	1 1/8"-high wood veneer top and wood composite edge with oversail front A	+\$321
TC1	1" cushion top	+\$394
TC2	2" cushion top	+\$394

Step 8. Lock		
<i>For 1"-high painted metal top with squared edge (T1), 1 1/4"-high painted metal top with squared edge (T2), 1 1/4"-high painted metal top with radius edge (T3), 1 1/4"-high recut veneer top (TR), 1 1/4"-high wood veneer top (TF), 1" cushion top (TC1), or 2" cushion top (TC2)</i>		
KA	keyed alike	-\$10
KC	keyed differently, chrome	+\$0
KD	keyed differently, black	+\$0

<i>For 1 1/4"-high laminate top with thermoplastic edge (TL), 6 1/2"-high planter top (T7), 6 1/2"-high full dome, side-to-side (D1), 6 1/2"-high half dome, sloping left (H1), 6 1/2"-high half dome, sloping right (H2), or 1 1/8"-high wood veneer top and wood composite edge with oversail front (TV1)</i>		
NL	no lock	-\$30

Step 9.		
Veneer Top Finish: Wood Veneer		
<i>For 1 1/4"-high wood veneer top (TF)</i>		
2U	light brown walnut A	+\$28
40	dark brown walnut A	+\$28
ED	aged cherry A	+\$28
EK	medium red walnut A	+\$28
EW	medium matte walnut A	+\$28
ET	clear on ash A	+\$28
EU	oak on ash A	+\$28
EV	walnut on ash A	+\$28
UL	natural maple A	+\$28
UX	walnut on cherry A	+\$28

Veneer Top Finish: Recut Veneer		
<i>For 1 1/4"-high recut veneer top (TR)</i>		
RA	light ash A	+\$0
RK	mahogany dark A	+\$0
RM	mahogany A	+\$0

Top Finish: Solid-Color Laminate		
<i>For 1 1/4"-high laminate top with thermoplastic edge (TL)</i>		
8Q	folkstone grey	+\$0
91	white	+\$0
98	studio white	+\$0
CL	cool grey neutral	+\$0
HF	inner tone light	+\$0
HT	inner tone	+\$0
LT	light tone	+\$0
LU	soft white	+\$0
WL	sandstone	+\$0
WN	warm grey neutral	+\$0

Top Finish: Linen Laminate		
<i>For 1 1/4"-high laminate top with thermoplastic edge (TL)</i>		
LBM	crisp linen	+\$0
LBN	classic linen	+\$0
LBP	casual linen	+\$0

Top Finish: Mesh Laminate		
<i>For 1 1/4"-high laminate top with thermoplastic edge (TL)</i>		
LBK	pewter mesh	+\$0
LBL	steel mesh	+\$0

Top Finish: Twill Laminate		
<i>For 1 1/4"-high laminate top with thermoplastic edge (TL)</i>		
LBF	neutral twill	+\$0
LBG	sarum twill	+\$0
LBH	earthen twill	+\$0
LBJ	graphite twill	+\$0
LBQ	white twill	+\$0

Bevel-Pull Mobile Lateral File

continued

Top Finish: Wood-Grain Laminate

For 1¹/₄"-high laminate top with thermoplastic edge (TL)

HM	natural maple	+\$0
HP	light anigre	+\$0
LA	light ash	+\$0
LBA	clear on ash	+\$0
LBB	oak on ash	+\$0
LBC	walnut on ash	+\$0
LBD	dark brown walnut	+\$0
LBR	phantom ecru	+\$0
LBS	phantom cocoa	+\$0
LBU	medium matte walnut	+\$0
LBV	warm grey teak	+\$0
LBE	medium red walnut	+\$0
LM	mahogany	+\$0
76	light brown walnut	+\$0
HX	aged cherry	+\$0
HY	walnut on cherry	+\$0

Top Finish: Zephyr Laminate

For 1¹/₄"-high laminate top with thermoplastic edge (TL)

28	canyon	+\$0
29	misted	+\$0

Veneer Top Finish: Wood Veneer

For 1¹/₈"-high wood veneer top and wood composite edge with oversail front (TV1)

40	dark brown walnut <input type="checkbox"/>	+\$28
ED	aged cherry <input type="checkbox"/>	+\$28
EK	medium red walnut <input type="checkbox"/>	+\$28
EW	medium matte walnut <input type="checkbox"/>	+\$28
ET	clear on ash <input type="checkbox"/>	+\$28
EU	oak on ash <input type="checkbox"/>	+\$28
EV	walnut on ash <input type="checkbox"/>	+\$28
UL	natural maple <input type="checkbox"/>	+\$28
UX	walnut on cherry <input type="checkbox"/>	+\$28

Step 10. Edge Finish

For 1¹/₄"-high laminate top with thermoplastic edge (TL)

28	canyon	+\$0
29	misted	+\$0
76	light brown walnut	+\$0
8Q	folkstone grey	+\$0
91	white	+\$0
98	studio white	+\$0
BU	black umber	+\$0
CL	cool grey neutral	+\$0

G2	graphite satin	+\$0
HF	inner tone light	+\$0
HM	natural maple	+\$0
HP	light anigre	+\$0
HT	inner tone	+\$0
HX	aged cherry	+\$0
HY	walnut on cherry	+\$0
LA	light ash	+\$0
LBA	clear on ash	+\$0
LBB	oak on ash	+\$0
LBC	walnut on ash	+\$0
LBD	dark brown walnut	+\$0
LBR	phantom ecru	+\$0
LBS	phantom cocoa	+\$0
LBU	medium matte walnut	+\$0
LBV	warm grey teak	+\$0
LBE	medium red walnut	+\$0
LBK	pewter mesh	+\$0
LBL	steel mesh	+\$0
LBM	crisp linen	+\$0
LBN	classic linen	+\$0
LBP	casual linen	+\$0
LBF	neutral twill	+\$0
LBG	sarum twill	+\$0
LBH	earthen twill	+\$0
LBJ	graphite twill	+\$0
LBQ	white twill	+\$0
LM	mahogany	+\$0
LU	soft white	+\$0
MT	medium tone	+\$0
SG	slate grey	+\$0
WA	wheat	+\$0
WL	sandstone	+\$0
WN	warm grey neutral	+\$0

Meridian® Mobile Stackable™ Lateral Files

Bevel-Pull Mobile Lateral File

continued

Meridian® Mobile Stackable™ Lateral Files

Step 11. Cushion Top Fabric		
<i>For 1" cushion top (TC1) or 2" cushion top (TC2)</i>		
<i>See textiles list for fabric numbers. First 2 digits of number indicate fabric line; remaining digit(s) indicate fabric color.</i>		
Price Category 1		+\$0
Price Category 2		+\$68
Price Category 3		+\$82
Price Category 4		+\$101
Price Category 5		+\$120
Price Category 7		+\$137
Price Category 8		+\$725
Price Category 9		+\$950
Price Category (Geiger) 10		+\$1050
Price Category B		+\$47
Price Category C		+\$65
Price Category D		+\$82
Price Category E		+\$99
Price Category F		+\$141
Price Category G		+\$166
Price Category H		+\$204
Price Category I		+\$264
Price Category J		+\$276
Price Category K		+\$310

Step 12. Drawer Interior		
9M	3 dividers	+\$0
9P	front-to-back filing rail	+\$0
9R	side-to-side filing rail	+\$0

Meridian® Low Credenza

C2A-3
C2A-4
C2K-3
C2K-4

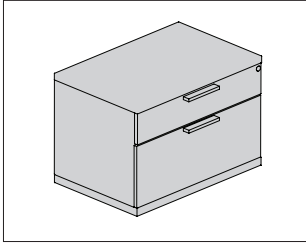

Product Information

Description

This credenza holds letter-, legal-, and A4-size hanging files in the file drawer. The box drawer provides for storage of miscellaneous supplies and personal items.

Actual credenza widths are 29⁷/₈" , 35⁷/₈" , or 41⁷/₈" ; actual depths are 17⁷/₈" or 19⁷/₈" .

Notes

Credenza case height is 17⁵/₈" .

Lock is standard in drawer front.

For base height option (LB2), overall height is 3¹/₂" consisting of 1¹/₂" tube base with 2" legs.

Dimensional illustrations do not include all possible configurations.

To convert filing direction, order 1 of the following products separately:

- Front-to-back rail (9Pxxxx)
- Side-to-side rail (9Rxxxx)

See Stackable Lateral File Accessories for specific product number.

Order optional file drawer organizer (LG901) separately.

For work surface on top of 1 or more credenzas, order file top (TPL or TPV) separately.

For cushion tops (TC1) and (TC2), a 1" metal top is included.

Cushion top accepts Customer's Own Material (COM). Yardage is estimated for nondirectional, 54"-wide fabrics. When ordering more than 1 cushion, round up total yardage requirement to next whole yard of fabric.

Width—Yardage

30" —1.05

36" —1.22

42" —1.40

For information on multiple quantities or directional fabrics, contact

COM Department. See Order Information in Appendices.

For keyed-alike locks, order lock plugs separately. See Keyed-Alike Information in Appendices.

Dimensions

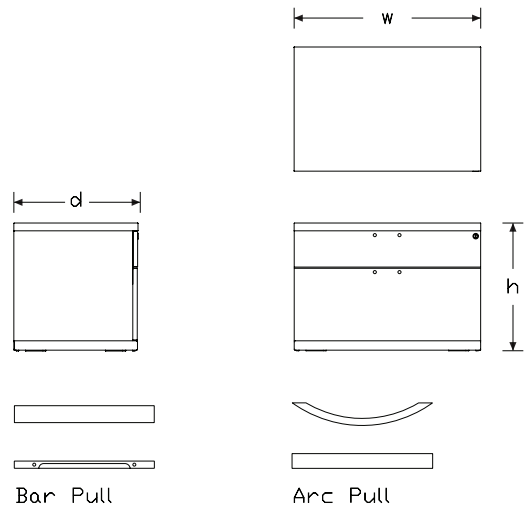

Meridian® Credenza Arc/Bar Pull

Specification Information			
Step 1.			
C2		A	
Step 2. Pull			
A-	arc pull	A	
K-	bar pull	A	
Step 3. Width			
30	30" wide	A	
36	36" wide	A	
42	42" wide	A	
Step 4. Depth			
18-	18" deep	A	
20-	20" deep	A	
Step 5. Configuration			
BF	box/file	A	
Step 6. Front Material			
M	painted metal	A	
V	veneer	A	
Prices for Steps 1-6.			
		M	V
C2A-30	18- BF	\$820	1263
	20- BF	\$820	1263
		M	V
C2A-36	18- BF	\$894	1457
	20- BF	\$894	1457
		M	V
C2A-42	18- BF	\$992	1706
	20- BF	\$992	1706
		M	V
C2K-30	18- BF	\$820	1263
	20- BF	\$820	1263
		M	V
C2K-36	18- BF	\$894	1457
	20- BF	\$894	1457
		M	V
C2K-42	18- BF	\$992	1706

20- BF		\$992	1706
Step 7. Paint/Steel Type			
SS	smooth paint on smooth steel		+\$0
TS	smooth paint on textured steel		+\$35
XS	textured paint on smooth steel		+\$0
Step 8. Surface Finish			
Nonmetallic Paint			
<i>For smooth paint on smooth steel (SS) or smooth paint on textured steel (TS)</i>			
8Q	folkstone grey		+\$0
91	white		+\$0
98	studio white A		+\$0
9J	sparrow		+\$0
BU	black umber		+\$0
G2	graphite satin		+\$0
HF	inner tone light		+\$0
HT	inner tone		+\$0
LT	light tone		+\$0
LU	soft white		+\$0
MT	medium tone		+\$0
SG	slate grey		+\$0
WA	wheat		+\$0
WL	sandstone		+\$0
Metallic Paint			
<i>For smooth paint on smooth steel (SS) or smooth paint on textured steel (TS)</i>			
1209	platinum		+\$0
1210	hematite		+\$0
1212	bronzite		+\$0
CN	metallic champagne		+\$0
EH	metallic bronze		+\$0
MS	metallic silver		+\$0
Sand Texture Paint			
<i>For textured paint on smooth steel (XS)</i>			
98	studio white A		+\$0
Bright Sand Texture Paint			
<i>For textured paint on smooth steel (XS)</i>			
91	white		+\$0
CL	cool grey neutral		+\$0
G1	graphite		+\$0
WN	warm grey neutral		+\$0

Step 9. Top

For painted metal (M)

NT	no top	+\$0
T2	1¼"-high painted metal top with squared edge	+\$0
TL	1¼"-high laminate top with thermoplastic edge	+\$74
TR	1¼"-high recut veneer top <input type="checkbox"/> A	+\$150
TF	1¼"-high wood veneer top <input type="checkbox"/> A	+\$156
TC1	1" cushion top	+\$394
TC2	2" cushion top	+\$394

For veneer (V)

NT	no top	+\$0
T2	1¼"-high painted metal top with squared edge	+\$0
TL	1¼"-high laminate top with thermoplastic edge	+\$74
TF	1¼"-high wood veneer top <input type="checkbox"/> A	+\$156
TC1	1" cushion top	+\$394
TC2	2" cushion top	+\$394

Step 10. Veneer Front Finish

For veneer (V) with no top (NT), 1¼"-high painted metal top with squared edge (T2), 1¼"-high laminate top with thermoplastic edge (TL), 1" cushion top (TC1), or 2" cushion top (TC2)

Wood Veneer

2U	light brown walnut <input type="checkbox"/> A	+\$56
40	dark brown walnut <input type="checkbox"/> A	+\$56
ED	aged cherry <input type="checkbox"/> A	+\$56
EK	medium red walnut <input type="checkbox"/> A	+\$56
EW	medium matte walnut <input type="checkbox"/> A	+\$56
ET	clear on ash <input type="checkbox"/> A	+\$56
EV	walnut on ash <input type="checkbox"/> A	+\$56
UL	natural maple <input type="checkbox"/> A	+\$56
UX	walnut on cherry <input type="checkbox"/> A	+\$56

Step 11.

Top Finish: Solid-Color Laminate

For 1¼"-high laminate top with thermoplastic edge (TL)

8Q	folkstone grey	+\$0
91	white	+\$0
CL	cool grey neutral	+\$0
HF	inner tone light	+\$0
HT	inner tone	+\$0
LT	light tone	+\$0
LU	soft white	+\$0
WL	sandstone	+\$0
WN	warm grey neutral	+\$0

Top Finish: Linen Laminate

For 1¼"-high laminate top with thermoplastic edge (TL)

LBM	crisp linen	+\$0
LBN	classic linen	+\$0
LBP	casual linen	+\$0

Top Finish: Mesh Laminate

For 1¼"-high laminate top with thermoplastic edge (TL)

LBK	pewter mesh	+\$0
LBL	steel mesh	+\$0

Top Finish: Twill Laminate

For 1¼"-high laminate top with thermoplastic edge (TL)

LBF	neutral twill	+\$0
LBG	sarum twill	+\$0
LBH	earthen twill	+\$0
LBJ	graphite twill	+\$0
LBQ	white twill	+\$0

Top Finish: Wood-Grain Laminate

For 1 1/4"-high laminate top with thermoplastic edge (TL)

76	light brown walnut	+\$0
HM	natural maple	+\$0
HP	light anigre	+\$0
HX	aged cherry	+\$0
HY	walnut on cherry	+\$0
LA	light ash	+\$0
LBA	clear on ash	+\$0
LBR	phantom ecru	+\$0
LBS	phantom cocoa	+\$0
LBU	medium matte walnut	+\$0
LBV	warm grey teak	+\$0
LBB	oak on ash	+\$0
LBC	walnut on ash	+\$0
LBD	dark brown walnut	+\$0
LBE	medium red walnut	+\$0
LM	mahogany	+\$0

Top Finish: Zephyr Laminate

For 1 1/4"-high laminate top with thermoplastic edge (TL)

28	canyon	+\$0
29	misted	+\$0

Veneer Top Finish: Recut Veneer

For painted metal (M) with 1 1/4"-high recut veneer top (TR)

RA	light ash A	+\$0
RK	mahogany dark A	+\$0
RM	mahogany A	+\$0

Veneer Top Finish: Wood Veneer

For painted metal (M) with 1 1/4"-high wood veneer top (TF)

2U	light brown walnut A	+\$28
40	dark brown walnut A	+\$28
ED	aged cherry A	+\$28
EK	medium red walnut A	+\$28
EW	medium matte walnut A	+\$28
ET	clear on ash A	+\$28
EV	walnut on ash A	+\$28
UL	natural maple A	+\$28
UX	walnut on cherry A	+\$28

Veneer Front/Top Finish: Wood Veneer

For veneer (V) with 1 1/4"-high wood veneer top (TF)

2U	light brown walnut A	+\$56
40	dark brown walnut A	+\$56
ED	aged cherry A	+\$56
EK	medium red walnut A	+\$56
EW	medium matte walnut A	+\$56
ET	clear on ash A	+\$56
EV	walnut on ash A	+\$56
UL	natural maple A	+\$56
UX	walnut on cherry A	+\$56

Step 12. Edge Finish

For 1 1/4"-high laminate top with thermoplastic edge (TL)

28	canyon	+\$0
29	misted	+\$0
76	light brown walnut	+\$0
8Q	folkstone grey	+\$0
91	white	+\$0
BU	black umber	+\$0
CL	cool grey neutral	+\$0
G2	graphite satin	+\$0
HF	inner tone light	+\$0
HM	natural maple	+\$0
HP	light anigre	+\$0
HT	inner tone	+\$0
HX	aged cherry	+\$0
HY	walnut on cherry	+\$0
LA	light ash	+\$0
LBA	clear on ash	+\$0
LBR	phantom ecru	+\$0
LBS	phantom cocoa	+\$0
LBU	medium matte walnut	+\$0
LBV	warm grey teak	+\$0
LBB	oak on ash	+\$0
LBC	walnut on ash	+\$0
LBD	dark brown walnut	+\$0
LBE	medium red walnut	+\$0
LBF	neutral twill	+\$0
LBG	sarum twill	+\$0
LBH	earthen twill	+\$0
LBJ	graphite twill	+\$0
LBK	pewter mesh	+\$0
LBL	steel mesh	+\$0
LBM	crisp linen	+\$0
LBN	classic linen	+\$0
LBP	casual linen	+\$0

LBQ	white twill	+\$0
LM	mahogany	+\$0
LU	soft white	+\$0
MT	medium tone	+\$0
SG	slate grey	+\$0
WA	wheat	+\$0
WL	sandstone	+\$0
WN	warm grey neutral	+\$0

Step 13. Cushion Top Fabric

For 1" cushion top (TC1) or 2" cushion top (TC2)

See application chart and textiles list for fabric usage and numbers.

First 2 digits of number indicate fabric line; remaining digit(s) indicate fabric color.

Price Category 1	+\$0
Price Category 2	+\$68
Price Category 3	+\$82
Price Category 4	+\$101
Price Category 5	+\$120
Price Category 7	+\$137
Price Category 8	+\$394
Price Category 9	+\$950
Price Category B	+\$47
Price Category C	+\$43
Price Category D	+\$82
Price Category E	+\$99
Price Category F	+\$99
Price Category G	+\$166
Price Category H	+\$204
Price Category I	+\$211
Price Category J	+\$276

Step 14. Lock

KA	keyed alike	-\$10
KC	keyed differently, chrome	+\$0
KD	keyed differently, black	+\$0

Step 15. Pull Finish

For arc pull (A-)

NH	brushed nickel	+\$0
NK	black nickel	+\$0

For bar pull (K-)

8Q	folkstone grey	+\$0
91	white	+\$0
98	studio white	+\$0
G1	graphite A	+\$0
WL	sandstone A	+\$0
CN	metallic champagne A	+\$0
MS	metallic silver	+\$0
79	green apple A	+\$10
MY3	yellow oxide A	+\$10
RO	red A	+\$10
TRQ	turquoise A	+\$10

Step 16. Base Height

B3	2 ¹ / ₄ "-high base	+\$0
LB2	1 ¹ / ₂ " leg base	+\$34

Step 17. Leg

For 1¹/₂" leg base (LB2)

DD	2"-high canvas leg A	+\$125
-----------	--	--------

Step 18. Leg Finish

91	white	+\$0
CL	cool grey neutral	+\$0
G1	graphite	+\$0
WN	warm grey neutral	+\$0

Metallic Paint

CN	metallic champagne A	+\$0
EH	metallic bronze A	+\$0
MS	metallic silver A	+\$0

Step 19. Counterweight

NO	no counterweight (must gang or anchor)	+\$0
CB	counterweight (recommended)	+\$122

Step 20. Drawer Interior

9M	3 dividers	+\$0
9P	front-to-back filing rail	+\$0
9R	side-to-side filing rail	+\$0

Meridian® File Top

TPL-0
TPL-1
TPV-0

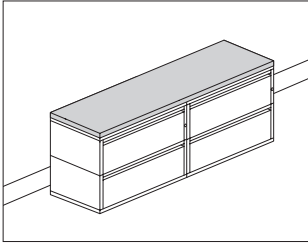

Meridian® File Tops

Product Information

Description
This file top attaches to a combination of freestanding Meridian® lateral files or storage cases with 18" or 20" depths. It has a laminate top with thermoplastic edge or a veneer top and edge.

Notes

Standard-pull files have lock located in side stile and do not require metal top under common top. Files with all other pull types will require metal top under common top to accommodate locks.

Suggested attachment methods:
 • Double-face tape
 • #10 wood screws with 1" maximum length
 Additional sizes and open-line laminates available through Vary Easy Exact Size Top Price Book (specIT edition only).

Dimensions

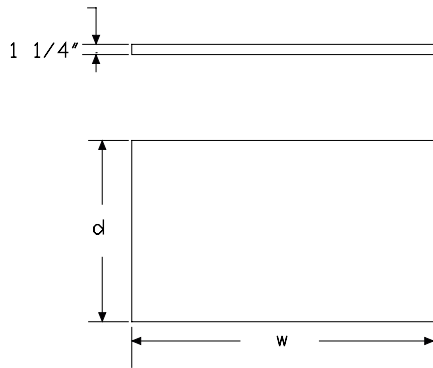

Specification Information

Step 1.

TP A

Step 2. Top/Edge Material

L- laminate top with thermoplastic edge A
V- veneer top with veneer edge A

Step 3. Width

For laminate top with thermoplastic edge (L-)

- 030** 30" wide A
- 036** 36" wide A
- 042** 42" wide A
- 060** 60" wide A
- 072** 72" wide A
- 084** 84" wide A
- 090** 90" wide A
- 108** 108" wide A

For veneer top with veneer edge (V-)

- 030** 30" wide A
- 036** 36" wide A
- 042** 42" wide A
- 060** 60" wide A
- 072** 72" wide A
- 084** 84" wide A
- 090** 90" wide A

Step 4. Depth

- 18** 18" deep A
- 20** 20" deep A
- 36** 36" deep A
- 40** 40" deep A

Prices for Steps 1-4.

TPL-030	18	\$149
	20	\$149
	36	\$333
	40	\$333
TPL-036	18	\$179
	20	\$179
	36	\$399
	40	\$399

TPL-042	18	\$208
	20	\$208
	36	\$464
	40	\$464

TPL-060	18	\$297
	20	\$297
	36	\$665
	40	\$665

TPL-072	18	\$356
	20	\$356
	36	\$797
	40	\$797

TPL-084	18	\$415
	20	\$415
	36	\$926
	40	\$926

TPL-090	18	\$445
	20	\$445
	36	\$997
	40	\$997

TPL-108	18	\$534
	20	\$534
	36	\$1196
	40	\$1196

TPV-030	18	\$369
	20	\$369
	36	\$588
	40	\$588

TPV-036	18	\$414
	20	\$414
	36	\$678
	40	\$678

TPV-042	18	\$458
	20	\$458
	36	\$765
	40	\$765

TPV-060	18	\$589
	20	\$589
	36	\$1029
	40	\$1029

TPV-072	18	\$680
	20	\$680
	36	\$1207
	40	\$1207

TPV-084	18	\$768
	20	\$768
	36	\$1384
	40	\$1384

TPV-090	18	\$810
	20	\$810
	36	\$1468
	40	\$1468

Step 5.

Top Finish: Solid-Color Laminate

For laminate top with thermoplastic edge (L-)

8Q	folkstone grey <input type="checkbox"/>	+\$0
91	white <input type="checkbox"/>	+\$0
98	studio white	+\$0
CL	cool grey neutral <input type="checkbox"/>	+\$0
HF	inner tone light <input type="checkbox"/>	+\$0
HT	inner tone <input type="checkbox"/>	+\$0
LT	light tone <input type="checkbox"/>	+\$0
LU	soft white <input type="checkbox"/>	+\$0
WL	sandstone <input type="checkbox"/>	+\$0
WN	warm grey neutral <input type="checkbox"/>	+\$0

Top Finish: Linen Laminate

For laminate top with thermoplastic edge (L-)

LBM	crisp linen	+\$0
LBN	classic linen	+\$0
LBP	casual linen	+\$0

Top Finish: Mesh Laminate

For laminate top with thermoplastic edge (L-)

LBK	pewter mesh	+\$0
LBL	steel mesh	+\$0

Top Finish: Twill Laminate		
<i>For laminate top with thermoplastic edge (L-)</i>		
LBF	neutral twill	+\$0
LBG	sarum twill	+\$0
LBH	earthen twill	+\$0
LBJ	graphite twill	+\$0
LBQ	white twill	+\$0

Top Finish: Wood-Grain Laminate		
<i>For laminate top with thermoplastic edge (L-)</i>		
HM	natural maple A	+\$0
HP	light anigre A	+\$0
LA	light ash A	+\$0
LBA	clear on ash	+\$0
LBB	oak on ash	+\$0
LBC	walnut on ash	+\$0
LBD	dark brown walnut	+\$0
LBR	phantom ecru	+\$0
LBS	phantom cocoa	+\$0
LBU	medium matte walnut	+\$0
LBV	warm grey teak	+\$0
LBE	medium red walnut	+\$0
LM	mahogany A	+\$0
76	light brown walnut A	+\$0
HX	aged cherry A	+\$0
HY	walnut on cherry A	+\$0

Top Finish		
<i>For laminate top with thermoplastic edge (L-)</i>		
28	canyon A	+\$0
29	misted A	+\$0

Top/Edge Finish: Wood Veneer		
<i>For veneer top with veneer edge (V-)</i>		
2U	light brown walnut A	+\$105
40	dark brown walnut A	+\$105
ED	aged cherry A	+\$105
EK	medium red walnut A	+\$105
EW	medium matte walnut A	+\$105
ET	clear on ash A	+\$105
EU	oak on ash A	+\$105
EV	walnut on ash A	+\$105
UL	natural maple A	+\$105
UX	walnut on cherry A	+\$105

Top/Edge Finish: Recut Veneer		
<i>For veneer top with veneer edge (V-)</i>		
RA	light ash A	+\$0
RK	mahogany dark A	+\$0
RM	mahogany A	+\$0

Step 6. Edge Finish		
<i>For laminate top with thermoplastic edge (L-)</i>		
LT	light tone A	+\$0
28	canyon A	+\$0
29	misted A	+\$0
76	light brown walnut A	+\$0
8Q	folkstone grey A	+\$0
91	white A	+\$0
98	studio white	+\$0
BU	black umber A	+\$0
CL	cool grey neutral A	+\$0
G2	graphite satin A	+\$0
HF	inner tone light A	+\$0
HM	natural maple A	+\$0
HP	light anigre A	+\$0
HT	inner tone A	+\$0
HX	aged cherry A	+\$0
HY	walnut on cherry A	+\$0
LA	light ash A	+\$0
LBA	clear on ash	+\$0
LBB	oak on ash	+\$0
LBC	walnut on ash	+\$0
LBD	dark brown walnut	+\$0
LBR	phantom ecru	+\$0
LBS	phantom cocoa	+\$0
LBU	medium matte walnut	+\$0
LBV	warm grey teak	+\$0
LBE	medium red walnut	+\$0
LBK	pewter mesh A	+\$0
LBL	steel mesh A	+\$0
LBM	crisp linen A	+\$0
LBN	classic linen A	+\$0
LBP	casual linen A	+\$0
LBF	neutral twill A	+\$0
LBG	sarum twill A	+\$0
LBH	earthen twill A	+\$0
LBJ	graphite twill A	+\$0
LBQ	white twill A	+\$0
LM	mahogany A	+\$0
LU	soft white A	+\$0
MT	medium tone A	+\$0

Meridian® File Top *continued*

SG	slate grey	<input type="checkbox"/> A	+\$0
WA	wheat	<input type="checkbox"/> A	+\$0
WL	sandstone	<input type="checkbox"/> A	+\$0
WN	warm grey neutral	<input type="checkbox"/> A	+\$0

Meridian® Storage Surround Top

FSTL-
FSTU-
FSTV-

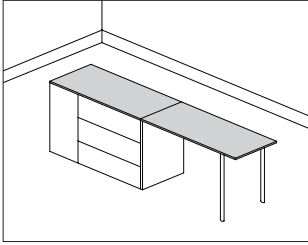

Product Information

Description

This surround top attaches to a combination of freestanding Meridian® lateral files or storage cases with 18" or 20" depths. It has a laminate top with thermoplastic edge, laminate top with a thermoplastic backed plywood edge, or veneer top and edge. Attachment hardware included.

Notes

Laminate tops up to and including 108" wide are 1-piece tops, and 120" wide and wider are 2-piece tops with connecting hardware.

Veneer tops up to and including 90" wide are 1-piece tops, and 108" wide and wider are 2-piece tops with connecting hardware.

Files with standard pulls have lock located in side stile and do not require metal top under common top. Files with all other pull types will require metal top under common top to accommodate locks.

Tops are required to be secured to storage case with the supplied #10 wood screws with 1" maximum length.

When using storage surround top (FST) independently of storage surround end (FSE), the top will oversail the end panel 1 1/4".

Meridian® File Surrounds

Dimensions

→ 60", 72", 84", 90", 108" ←



← 120", 126", 144", 150", 168", 180" →

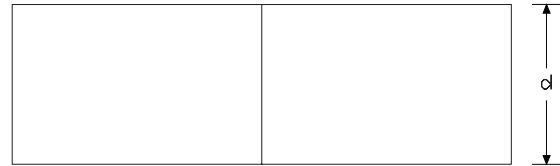

laminate top

← 60", 72", 84", 90" →



← 108", 120", 126", 144", 150", 168", 180" →

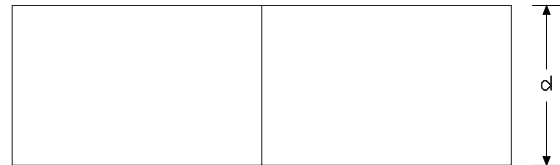

veneer top

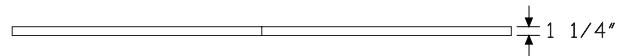

Meridian® Storage Surround Top

continued

Specification Information

Step 1.

FST A

Step 2. Top/Edge Material

L- laminate top with thermoplastic edge A

V- veneer top with veneer edge A

U- laminate top with universal edge A

Step 3. Width

060 60" wide A

072 72" wide A

084 84" wide A

090 90" wide A

108 108" wide A

120 120" wide A

126 126" wide A

144 144" wide A

150 150" wide A

168 168" wide A

180 180" wide A

Step 4. Depth

18 18" deep A

20 20" deep A

36 36" deep A

40 40" deep A

Prices for Steps 1-4.

		18	20	36	40
FSTL-	060	\$325	325	665	665
	072	\$383	383	797	797
	084	\$442	442	930	930
	090	\$472	472	996	996
	108	\$559	559	1195	1195
	120	\$1241	1241	1699	1699
	126	\$1270	1270	1765	1765
	144	\$1358	1358	1964	1964
	150	\$1388	1388	2029	2029
	168	\$1476	1476	2228	2228
	180	\$1535	1535	2361	2361

FSTV-	060	\$686	686	1139	1139
	072	\$777	777	1315	1315
	084	\$866	866	1492	1492
	090	\$912	912	1580	1580
	108	\$1603	1603	1963	1963
	120	\$1694	1694	2305	2305
	126	\$1739	1739	2228	2228
	144	\$1874	1874	2493	2493
	150	\$1919	1919	2581	2581
	168	\$2055	2055	2846	2846
	180	\$2146	2146	3023	3023

FSTU-	060	\$325	325	665	665
	072	\$383	383	797	797
	084	\$442	442	930	930
	090	\$472	472	996	996
	108	\$559	559	1195	1195
	120	\$1241	1241	1699	1699
	126	\$1270	1270	1765	1765
	144	\$1358	1358	1964	1964
	150	\$1388	1388	2029	2029
	168	\$1476	1476	2228	2228
	180	\$1535	1535	2361	2361

Step 5. Top Finish

Solid-Color Laminate

For laminate top with thermoplastic edge (L-) or laminate top with universal edge (U-)

8Q	folkstone grey <input type="checkbox"/> A	+\$0
91	white <input type="checkbox"/> A	+\$0
CL	cool grey neutral <input type="checkbox"/> A	+\$0
HF	inner tone light <input type="checkbox"/> A	+\$0
HT	inner tone <input type="checkbox"/> A	+\$0
LT	light tone <input type="checkbox"/> A	+\$0
LU	soft white <input type="checkbox"/> A	+\$0
WL	sandstone <input type="checkbox"/> A	+\$0
WN	warm grey neutral <input type="checkbox"/> A	+\$0

Linen Laminate

For laminate top with thermoplastic edge (L-) or laminate top with universal edge (U-)

LBM	crisp linen	+\$0
LBN	classic linen	+\$0
LBP	casual linen	+\$0

Meridian® Storage Surround Top

continued

Meridian® File Surrounds

Mesh Laminate

For laminate top with thermoplastic edge (L-) or laminate top with universal edge (U-)

LBK	pewter mesh	+\$0
LBL	steel mesh	+\$0

Twill Laminate

For laminate top with thermoplastic edge (L-) or laminate top with universal edge (U-)

LBF	neutral twill	+\$0
LBG	sarum twill	+\$0
LBH	earthen twill	+\$0
LBJ	graphite twill	+\$0
LBQ	white twill	+\$0

Wood-Grain Laminate

For laminate top with thermoplastic edge (L-) or laminate top with universal edge (U-)

HM	natural maple A	+\$0
HP	light anigre A	+\$0
LA	light ash A	+\$0
LBA	clear on ash	+\$0
LBB	oak on ash	+\$0
LBC	walnut on ash	+\$0
LBD	dark brown walnut	+\$0
LBR	phantom ecru	+\$0
LBS	phantom cocoa	+\$0
LBU	medium matte walnut	+\$0
LBV	warm grey teak	+\$0
LBE	medium red walnut	+\$0
LM	mahogany A	+\$0
76	light brown walnut A	+\$0
HX	aged cherry A	+\$0
HY	walnut on cherry A	+\$0

Zephyr Laminate

For laminate top with thermoplastic edge (L-) or laminate top with universal edge (U-)

28	canyon A	+\$0
29	misted A	+\$0

Wood Veneer

For veneer top with veneer edge (V-)

V3	cherry A	+\$82
Z3	warm red cherry A	+\$82
Z5	maple A	+\$82
2U	light brown walnut A	+\$105
3U	medium red cherry A	+\$105
40	dark brown walnut A	+\$105
6U	chocolate brown sapele A	+\$105
ED	aged cherry A	+\$105
EG	medium brown walnut A	+\$105
EK	medium red walnut A	+\$105
EW	medium matte walnut A	+\$105
ET	clear on ash A	+\$105
EU	oak on ash A	+\$105
EV	walnut on ash A	+\$105
UL	natural maple A	+\$105
UQ	light cherry A	+\$105
UV	red cherry A	+\$105
UX	walnut on cherry A	+\$105

Recut Veneer

For veneer top with veneer edge (V-)

RA	light ash A	+\$0
RK	mahogany dark A	+\$0
RM	mahogany A	+\$0

Step 6. Edge Finish

For laminate top with thermoplastic edge (L-)

28	canyon A	+\$0
29	misted A	+\$0
76	light brown walnut A	+\$0
8Q	folkstone grey A	+\$0
91	white A	+\$0
BU	black umber A	+\$0
CL	cool grey neutral A	+\$0
G2	graphite satin A	+\$0
HF	inner tone light A	+\$0
HM	natural maple A	+\$0
HP	light anigre A	+\$0
HT	inner tone A	+\$0
HX	aged cherry A	+\$0
HY	walnut on cherry A	+\$0
LA	light ash A	+\$0
LBA	clear on ash	+\$0
LBB	oak on ash	+\$0

Meridian® Storage Surround Top

continued

LBC	walnut on ash	+\$0
LBD	dark brown walnut	+\$0
LBR	phantom ecru	+\$0
LBS	phantom cocoa	+\$0
LBU	medium matte walnut	+\$0
LBV	warm grey teak	+\$0
LBE	medium red walnut	+\$0
LBK	pewter mesh <input type="checkbox"/> A	+\$0
LBL	steel mesh <input type="checkbox"/> A	+\$0
LBM	crisp linen <input type="checkbox"/> A	+\$0
LBN	classic linen <input type="checkbox"/> A	+\$0
LBP	casual linen <input type="checkbox"/> A	+\$0
LBF	neutral twill <input type="checkbox"/> A	+\$0
LBG	sarum twill <input type="checkbox"/> A	+\$0
LBH	earthen twill <input type="checkbox"/> A	+\$0
LBJ	graphite twill <input type="checkbox"/> A	+\$0
LBQ	white twill <input type="checkbox"/> A	+\$0
LM	mahogany <input type="checkbox"/> A	+\$0
LU	soft white <input type="checkbox"/> A	+\$0
MT	medium tone <input type="checkbox"/> A	+\$0
SG	slate grey <input type="checkbox"/> A	+\$0
WA	wheat <input type="checkbox"/> A	+\$0
WL	sandstone <input type="checkbox"/> A	+\$0
WN	warm grey neutral <input type="checkbox"/> A	+\$0

For laminate top with universal edge (U-)

PLY	plywood edge <input type="checkbox"/> A	+\$50
------------	---	-------

Meridian® Storage Surround Ends FSEL-
FSEV-

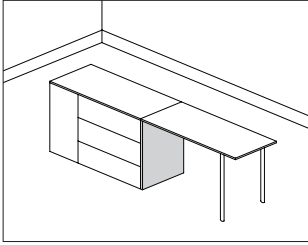

Meridian® File Surrounds

Product Information

Description
This surround end attaches to a combination of freestanding Meridian® lateral files or storage cases with 18" or 20" depths. It has a laminate top with thermoplastic edge or a veneer top and edge. Attachment hardware included.

Notes

Pricing is for a single file end.
Surround end is attached to storage case only. Ends are not designed to support a surround top at the open end.
Surround end heights are designed to align with the following case, base, and top specifications:

- 37—aligns with 35 1/4" case height with 2 1/4" base and no top
- 38—aligns with 35 1/4" case height with 2 1/4" base and 1 1/4" top
- 41—aligns with 39 3/8" case height with 2 1/4" base and no top
- 42—aligns with 39 3/8" case height with 2 1/4" base and 1 1/4" top

Files with standard pulls have lock located in side stile and do not require metal top under common top. Files with all other pull types will require metal top under common top to accommodate locks. When ordering tops, consider the thickness of end panel (1 1/4") to allow top over design.
Ends are secured to storage case with the supplied #10 wood screws with 1" maximum length.
Additional sizes and open-line laminates available through Vary Easy Exact Size Top Price Book (SpecIT edition only).

Dimensions

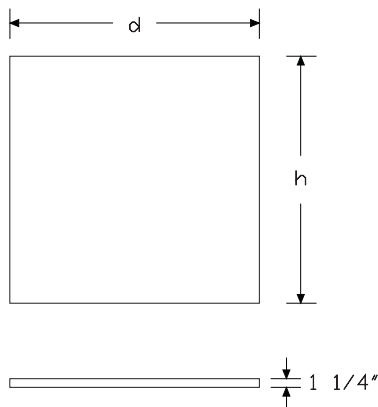

Specification Information

Step 1.

FSE [A]

Step 2. End/Edge Material

L- laminate end with thermoplastic edge [A]
V- veneer end with veneer edge [A]

Step 3. Height

37 37.5" high [A]
38 38.75" high [A]
41 41.625" high [A]
42 42.875" high [A]

Step 4. Depth

18 18" deep [A]
20 20" deep [A]
36 36" deep [A]
40 40" deep [A]

Prices for Steps 1-4.

		18	20	36	40
FSEL-	37	\$274	274	390	390
	38	\$279	279	395	395
	41	\$285	285	400	400
	42	\$290	290	405	405
FSEV-	37	\$600	600	852	852
	38	\$610	610	862	862
	41	\$621	621	873	873
	42	\$631	631	884	884

Step 5.

End Finish: Solid-Color Laminate

For laminate end with thermoplastic edge (L-)

8Q	folkstone grey [A]	+\$0
91	white [A]	+\$0
CL	cool grey neutral [A]	+\$0
HF	inner tone light [A]	+\$0
HT	inner tone [A]	+\$0
LT	light tone [A]	+\$0
LU	soft white [A]	+\$0
WL	sandstone [A]	+\$0
WN	warm grey neutral [A]	+\$0

Meridian® Storage Surround Ends

continued

End Finish: Frosted Laminate

For laminate end with thermoplastic edge (L-)

J4	frosted light grey <input type="checkbox"/>	+\$0
-----------	---	------

End Finish: Linen Laminate

For laminate end with thermoplastic edge (L-)

LBM	crisp linen <input type="checkbox"/>	+\$0
LBN	classic linen <input type="checkbox"/>	+\$0
LBP	casual linen <input type="checkbox"/>	+\$0

End Finish: Mesh Laminate

For laminate end with thermoplastic edge (L-)

LBK	pewter mesh <input type="checkbox"/>	+\$0
LBL	steel mesh <input type="checkbox"/>	+\$0

End Finish: Twill Laminate

For laminate end with thermoplastic edge (L-)

LBF	neutral twill <input type="checkbox"/>	+\$0
LBG	sarum twill <input type="checkbox"/>	+\$0
LBH	earthen twill <input type="checkbox"/>	+\$0
LBJ	graphite twill <input type="checkbox"/>	+\$0
LBQ	white twill <input type="checkbox"/>	+\$0

End Finish: Wood-Grain Laminate

For laminate end with thermoplastic edge (L-)

76	light brown walnut <input type="checkbox"/>	+\$0
HM	natural maple <input type="checkbox"/>	+\$0
HP	light anigre <input type="checkbox"/>	+\$0
HX	aged cherry <input type="checkbox"/>	+\$0
HY	walnut on cherry <input type="checkbox"/>	+\$0
LA	light ash <input type="checkbox"/>	+\$0
LBA	clear on ash <input type="checkbox"/>	+\$0
LBR	phantom ecru <input type="checkbox"/>	+\$0
LBS	phantom cocoa <input type="checkbox"/>	+\$0
LBU	medium matte walnut <input type="checkbox"/>	+\$0
LBV	warm grey teak <input type="checkbox"/>	+\$0
LBB	oak on ash <input type="checkbox"/>	+\$0
LBC	walnut on ash <input type="checkbox"/>	+\$0
LBD	dark brown walnut <input type="checkbox"/>	+\$0
LBE	medium red walnut <input type="checkbox"/>	+\$0
LM	mahogany <input type="checkbox"/>	+\$0

End Finish: Zephyr Laminate

For laminate end with thermoplastic edge (L-)

28	canyon <input type="checkbox"/>	+\$0
29	misted <input type="checkbox"/>	+\$0

End/Edge Finish: Wood Veneer

For veneer end with veneer edge (V-)

V3	cherry <input type="checkbox"/>	+\$0
Z3	warm red cherry <input type="checkbox"/>	+\$0
Z5	maple <input type="checkbox"/>	+\$0
2U	light brown walnut <input type="checkbox"/>	+\$82
3U	medium red cherry <input type="checkbox"/>	+\$82
40	dark brown walnut <input type="checkbox"/>	+\$82
6U	chocolate brown sapele <input type="checkbox"/>	+\$82
ED	aged cherry <input type="checkbox"/>	+\$82
EG	medium brown walnut <input type="checkbox"/>	+\$82
EK	medium red walnut <input type="checkbox"/>	+\$82
EW	medium matte walnut <input type="checkbox"/>	+\$82
ET	clear on ash <input type="checkbox"/>	+\$82
EU	oak on ash <input type="checkbox"/>	+\$82
EV	walnut on ash <input type="checkbox"/>	+\$82
UL	natural maple <input type="checkbox"/>	+\$82
UQ	light cherry <input type="checkbox"/>	+\$82
UV	red cherry <input type="checkbox"/>	+\$82
UX	walnut on cherry <input type="checkbox"/>	+\$82

End/Edge Finish: Recut Veneer

For veneer end with veneer edge (V-)

RA	light ash <input type="checkbox"/>	+\$0
RK	mahogany dark <input type="checkbox"/>	+\$0
RM	mahogany <input type="checkbox"/>	+\$0

Step 6. Edge Finish

For laminate end with thermoplastic edge (L-)

28	canyon <input type="checkbox"/>	+\$0
29	misted <input type="checkbox"/>	+\$0
76	light brown walnut <input type="checkbox"/>	+\$0
8Q	folkstone grey <input type="checkbox"/>	+\$0
91	white <input type="checkbox"/>	+\$0
BU	black umber <input type="checkbox"/>	+\$0
CL	cool grey neutral <input type="checkbox"/>	+\$0
G2	graphite satin <input type="checkbox"/>	+\$0
HF	inner tone light <input type="checkbox"/>	+\$0
HM	natural maple <input type="checkbox"/>	+\$0
HP	light anigre <input type="checkbox"/>	+\$0
HT	inner tone <input type="checkbox"/>	+\$0
HX	aged cherry <input type="checkbox"/>	+\$0
HY	walnut on cherry <input type="checkbox"/>	+\$0
LA	light ash <input type="checkbox"/>	+\$0
LBA	clear on ash	+\$0
LBB	oak on ash	+\$0
LBC	walnut on ash	+\$0

Meridian® Storage Surround Ends

continued

Meridian® File Surrounds

LBD	dark brown walnut	+\$0
LBR	phantom ecru	+\$0
LBS	phantom cocoa	+\$0
LBU	medium matte walnut	+\$0
LBV	warm grey teak	+\$0
LBE	medium red walnut	+\$0
LBK	pewter mesh <input type="checkbox"/> A	+\$0
LBL	steel mesh <input type="checkbox"/> A	+\$0
LBM	crisp linen <input type="checkbox"/> A	+\$0
LBN	classic linen <input type="checkbox"/> A	+\$0
LBP	casual linen <input type="checkbox"/> A	+\$0
LBF	neutral twill <input type="checkbox"/> A	+\$0
LBG	sarum twill <input type="checkbox"/> A	+\$0
LBH	earthen twill <input type="checkbox"/> A	+\$0
LBJ	graphite twill <input type="checkbox"/> A	+\$0
LBQ	white twill <input type="checkbox"/> A	+\$0
LM	mahogany <input type="checkbox"/> A	+\$0
LU	soft white <input type="checkbox"/> A	+\$0
MT	medium tone <input type="checkbox"/> A	+\$0
SG	slate grey <input type="checkbox"/> A	+\$0
WA	wheat <input type="checkbox"/> A	+\$0
WL	sandstone <input type="checkbox"/> A	+\$0
WN	warm grey neutral <input type="checkbox"/> A	+\$0

Meridian® Storage Surround
Support Legs

FSLR-
FSLV-

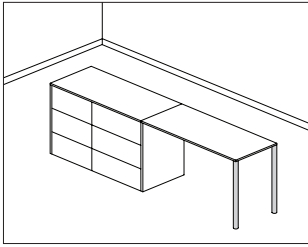

Product Information

Description

This metal leg attaches to a surround top in lieu of a surround end panel. Each leg has an adjustable glide with 1½" of height adjustment.

Specified and shipped as a pair (2).

Surround legs are designed to align with the following case, base, and top specifications:

- 37—aligns with 35¼" case height with 2¼" base and no top
- 38—aligns with 35¼" case height with 2¼" base and 1¼" top
- 41—aligns with 39⅜" case height with 2¼" base and no top
- 42—aligns with 39⅜" case height with 2¼" base and 1¼" top

Notes

Legs are used to support 1 end of file surround top (FSTL-, FSLV-), and leg height matches height of file surround end panel (FSEL-, FSEV-).

Dimensions

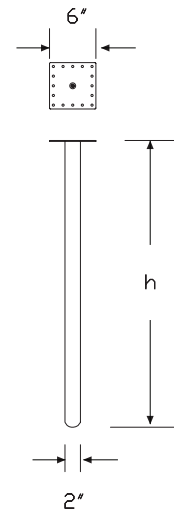

round

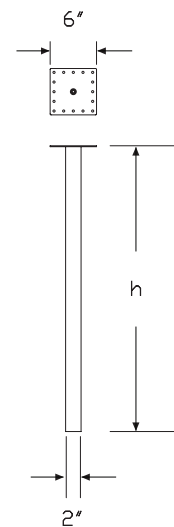

square

Meridian® Storage Surround

Support Legs *continued*

Specification Information		
Step 1.		
FSL	<input type="checkbox"/> A	
Step 2. Leg Style		
R-	round <input type="checkbox"/> A	
S-	square <input type="checkbox"/> A	
Step 3. Height		
37	37.5" high <input type="checkbox"/> A	
38	38.75" high <input type="checkbox"/> A	
41	41.625" high <input type="checkbox"/> A	
42	42.875" high <input type="checkbox"/> A	
Prices for Steps 1-3.		
FSLR-		
37		\$305
38		\$305
41		\$332
42		\$332
FSLS-		
37		\$411
38		\$411
41		\$432
42		\$432
Step 4. Paint/Steel Type		
SS	smooth paint on smooth steel <input type="checkbox"/> A	+\$0
XS	textured paint on smooth steel <input type="checkbox"/> A	+\$0
Step 5. Surface Finish		
Bright Sand Texture Paint		
<i>For textured paint on smooth steel (XS)</i>		
91	white <input type="checkbox"/> A	+\$0
G1	graphite <input type="checkbox"/> A	+\$0
Metallic Paint		
<i>For smooth paint on smooth steel (SS)</i>		
MS	metallic silver <input type="checkbox"/> A	+\$0

Front-to-Back Filing Rail,
Meridian® Stackable™ Lateral File

9P001
9P002
9P361
9P362

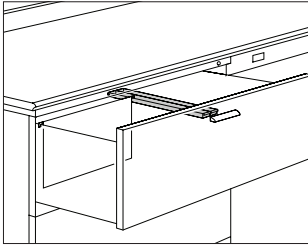

Product Information

Description

This filing rail holds letter-size hanging folders for front-to-back filing. The 16" rail is used in an 18"-deep Meridian® lateral file drawer. The 18" rail is used in the file drawer of a Meridian Stackable Storage™ cabinet bottom module, 20"-deep Meridian lateral file, or Meridian lateral storage tower.

Notes

Front-to-back filing rail cannot be used in Tu® or Quadrant® lateral file drawers.

Dimensions

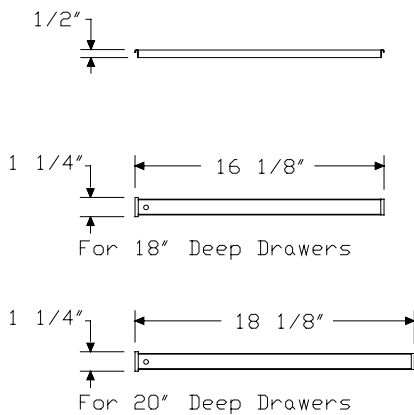

Specification Information

Step 1.

9P

Step 2. Width

00 for 30"- or 42"-wide drawers
36 for 36"-wide drawers

Step 3. Depth

18 18" deep
20 20" deep

Prices for Steps 1-3.

9P0018	\$28
9P0020	\$28
9P3618	\$28
9P3620	\$28

Meridian® Stackable™ Lateral File Accessories

Side-to-Side Filing Rail, Meridian®
Stackable™ Lateral File

- 9R124
- 9R130
- 9R136
- 9R142
- 9R224
- 9R230
- 9R236
- 9R242

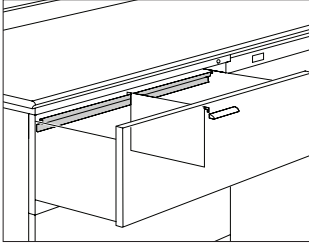

Product Information

Description

This filing rail holds letter- or legal-size hanging folders for side-to-side filing. The 21"-wide rail is used in the file drawer of a 24"-wide Meridian® Stackable Storage™ cabinet bottom module. The 27"-wide rail is used in the file drawer of a 30"-wide Meridian Stackable Storage cabinet bottom module, Meridian lateral file, or Meridian lateral storage tower. The 33"-wide rail is used in the file drawer of a 36"-wide Meridian lateral file. The 39"-wide rail is used in the file drawer of a 42"-wide Meridian lateral file.

Notes

Side-to-side filing rail cannot be used in Tu® or Quadrant® lateral file drawers.

Dimensions

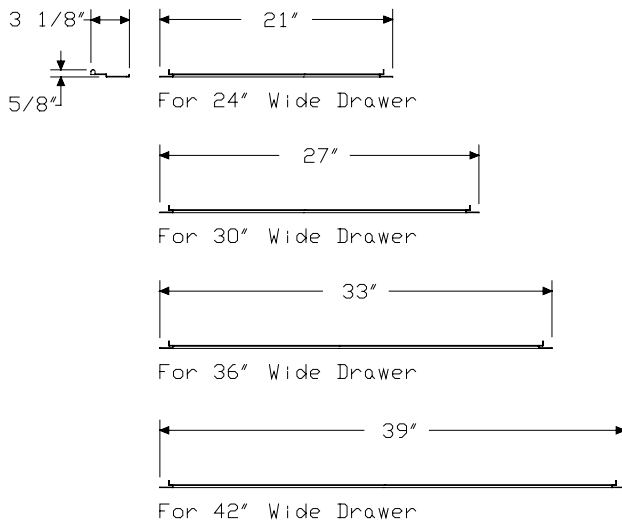

Specification Information

Step 1.

9R

Step 2. Quantity

- 1** 1 filing rail
- 2** 2 filing rails

Step 3. Width

- 2400** for 24"-wide drawers
- 3000** for 30"-wide drawers
- 3600** for 36"-wide drawers
- 4200** for 42"-wide drawers

Prices for Steps 1-3.

9R12400	\$21
9R13000	\$21
9R13600	\$21
9R14200	\$21
9R22400	\$41
9R23000	\$41
9R23600	\$41
9R24200	\$41

Movable Divider, Meridian®, 9M100
 Quadrant® or Tu® 9M300

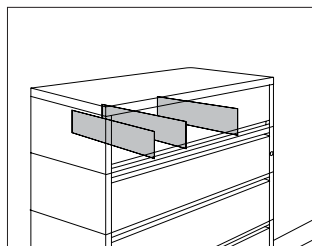

Product Information

Description

This adjustable metal divider fits into slots of an 18"- or 20"-deep Meridian® Stackable™ lateral file drawer. The 18"-deep divider also fits into a pullout shelf's slots on a Tu® or Quadrant® 5-high lateral file. Finish is black umber.

Dimensions

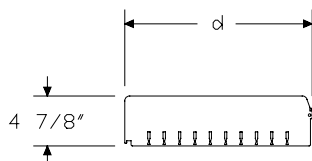

Specification Information

Step 1.

9M

Step 2. Quantity

100 1 divider
300 3 dividers

Step 3. Depth

18 for Meridian® 18"-deep Stackable™ lateral file modules or
 Quadrant® 20" deep flipper door with pullout shelf
20 for Meridian® 20" deep Stackable™ lateral file modules

Prices for Steps 1-3.

9M100	18	\$15
	20	\$15
9M300	18	\$35
	20	\$35

Meridian® Stackable™ Lateral File Accessories

File Drawer Organizer

LG901

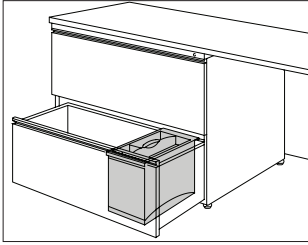

Product Information

Description

This 2-sectioned organizer fits into any file drawer arranged for letter-size filing. The removable top section stores computer disks and other small items. The bottom section stores larger items or can be divided into 3 compartments; it includes 2 vertical dividers. Finish is black umber.

Dimensions

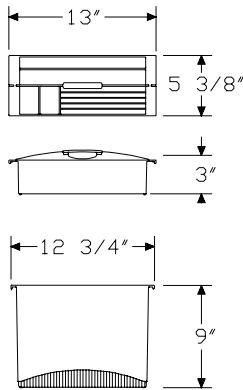

Specification Information

Step 1.

LG901

\$79

EnhancedAccess™ Pull

EAP-L

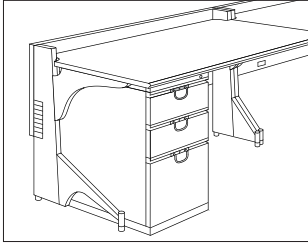

Product Information

Description

This plastic loop-style pull slides into the standard pull or Tu® W-pull on a pedestal or lateral file drawer. It makes the drawer easier to open. Package contains 1 pull and attachment hardware.

Dimensions

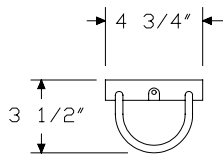

Specification Information

Step 1.

EAP-

Step 2. Pull Style

L loop

Prices for Steps 1-2.

EAP-L \$54

Step 3. Finish

BU	black umber	+\$0
HF	inner tone light	+\$0
MT	medium tone	+\$0

Label Holders-Snap In and Adhesive

9LH5H
9LH7H

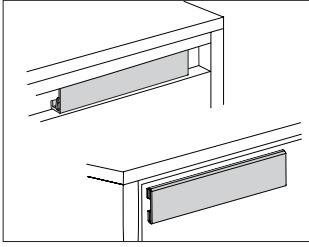

Product Information

Description
These label holders snap in place for standard pull file drawers or attach with adhesive onto drawers with other pull styles. Package contains 25 of the specified style. Labels included.

Dimensions

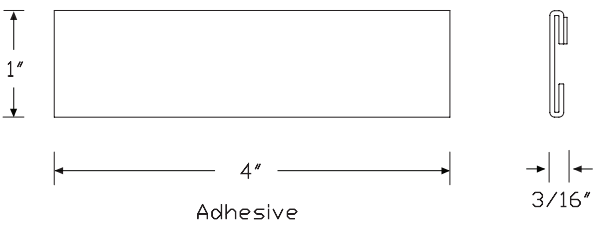
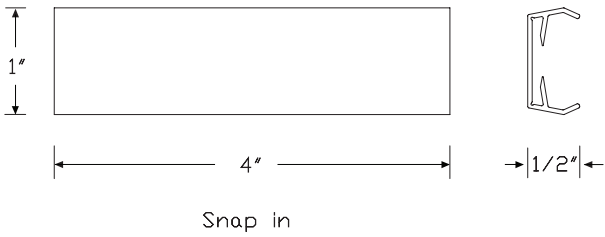

Specification Information

Step 1.

9LH

Step 2. Style

5HV snap in

7HT adhesive

Prices for Steps 1-2.

9LH5HV \$20

9LH7HT \$18

Keyless Lock

MKL-H
 MKL-V
 MKS-H
 MKS-V

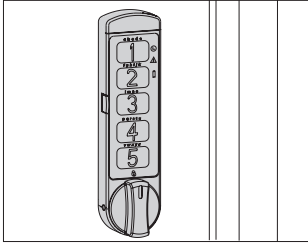

Product Information

Description

This keyless lock replaces an existing cam lock and is available in 2 mode options. Locker mode allows for a temporary code to be entered for each use, and station mode allows for repeated use with the same code. Multiple orientation options allow the keyless lock to be used with a variety of products.

Notes

Replacement battery is a 3-volt lithium CR2032 battery.
 Actual lock dimensions are 3.86"W x 1.00"H x 0.39"D.
 Meridian® standard pull 2600 series, the Tu® metal pedestal, and some Tu metal lateral files will not accommodate the width of the keyless lock.

Order the following products separately:

- Control key fob (MKL-CKF)
- User key fob (MKL-UKF)

This keyless lock can be found under the Meridian® product line code of MS.

Dimensions

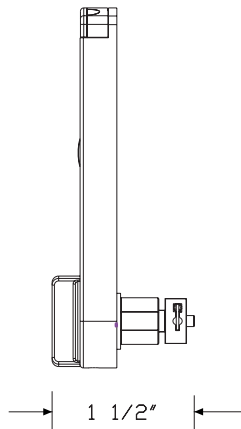
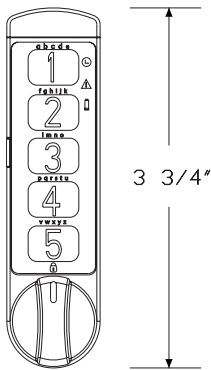
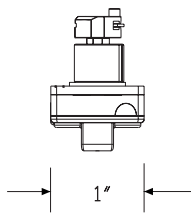

Specification Information

Step 1.

MK

Step 2. Mode

L- locker mode

S- station mode

Step 3. Orientation

HL horizontal, keypad facing left

HR horizontal, keypad facing right

VU vertical, keypad facing up

VD vertical, keypad facing down

Prices for Steps 1-3.

MKL-HL	\$203
MKL-HR	\$203
MKL-VU	\$203
MKL-VD	\$203
MKS-HL	\$203
MKS-HR	\$203
MKS-VU	\$203
MKS-VD	\$203

Step 4. Finish

OI silver <input type="checkbox"/>	+ \$0
BK black <input type="checkbox"/>	+ \$0

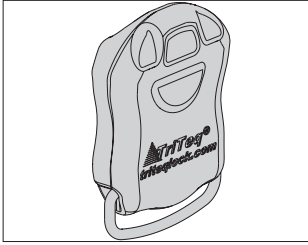

Product Information

Description
This key fob opens the keyless lock without using the numeric keypad.

Notes

Order the following products separately:

- Keyless lock (MK)
- User key fob (MKL-UKF)

.....

This keyless lock, control key fob can be found under the Meridian® product line code of MS.

Dimensions

Meridian® Keyless Locks

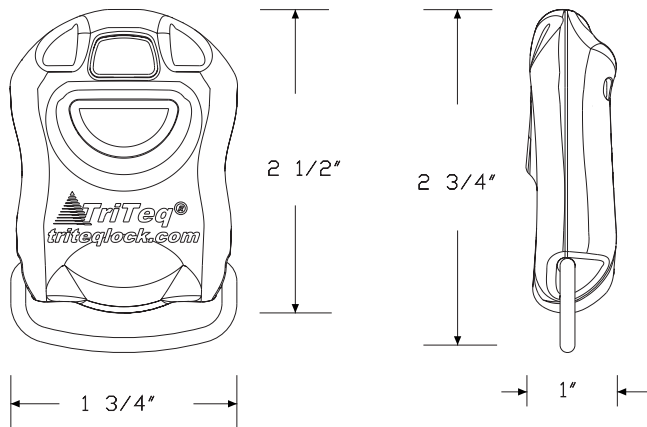

Specification Information

Step 1.
MKL-CKF A \$173

Keyless Lock, User Key Fob

MKL-U



Product Information

Description

This key fob opens the keyless lock without using the numeric keypad.

Notes

Order the following products separately:

- Keyless lock (MK)
- Control key fob (MKL-CKF)

This keyless lock, user key fob can be found under the Meridian® product line code of MS.

Dimensions

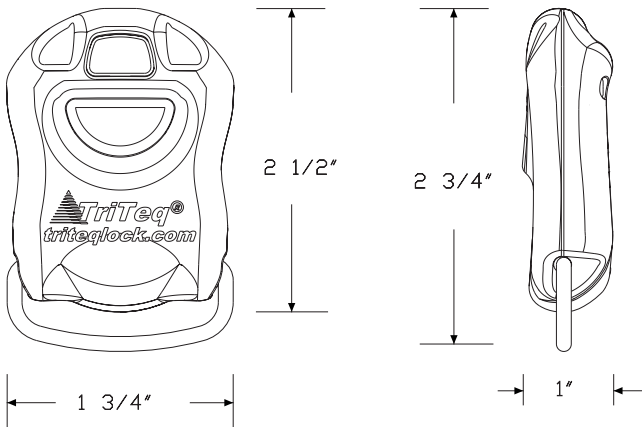

Specification Information

Step 1.

MKL-UKF A

\$173

Index by Product Name

Meridian® Lateral Files	
Arc-Pull Freestanding Lateral File	page(s) 30
Bar-Pull Freestanding Lateral File	36
Bevel-Pull Freestanding Lateral File	42
Bevel-Pull Mobile Lateral File	66
Ellipse-Pull Freestanding Lateral File	47
EnhancedAccess™ Pull	93
File Drawer Organizer	92
Front-to-Back Filing Rail, Meridian® Stackable™ Lateral File	89
Keyless Lock	95
Keyless Lock, Control Key Fob	96
Keyless Lock, User Key Fob	97
Label Holders-Snap In and Adhesive	94
Meridian® File Top	76
Meridian® Low Credenza	71
Meridian® Storage Surround Ends	84
Meridian® Storage Surround Support Legs	87
Meridian® Storage Surround Top	80
Movable Divider, Meridian®, Quadrant® or Tu®	91
Retrofit Cushion Top	59
Side-to-Side Filing Rail, Meridian® Stackable™ Lateral File	90
Sloped-Pull Freestanding Lateral File	53
Standard-Pull Freestanding Lateral File	25
Standard-Pull Mobile Lateral File	61

Index by Product Number

2A-30	Arc-Pull Freestanding Lateral File	page(s) 30	FSL-		
2A-36			FSTL-	Meridian® Storage Surround Top	80
2A-42			FSTU-		
2D-30			FSTV-		
2D-36			LG901	File Drawer Organizer	92
2D-42			M24-3	Bevel-Pull Mobile Lateral File	66
2J-30	Ellipse-Pull Freestanding Lateral File	47	M24-4		
2J-36			M26-3	Standard-Pull Mobile Lateral File	61
2J-42			M26-4		
2KP-3	Bar-Pull Freestanding Lateral File	36	MKL-C	Keyless Lock, Control Key Fob	96
2KP-4			MKL-H	Keyless Lock	95
2KV-3			MKL-U	Keyless Lock, User Key Fob	97
2KV-4			MKL-V	Keyless Lock	95
9LH5H	Label Holders-Snap In and Adhesive	94	MKS-H		
9LH7H			MKS-V		
9M100	Movable Divider, Meridian®, Quadrant® or Tu®	91	TC1-3	Retrofit Cushion Top	59
9M300			TC1-4		
9P001	Front-to-Back Filing Rail, Meridian® Stackable™ Lateral File	89	TC2-3		
9P002			TC2-4		
9P361			TPL-0	Meridian® File Top	76
9P362			TPL-1		
9R124	Side-to-Side Filing Rail, Meridian® Stackable™ Lateral File	90	TPV-0		
9R130					
9R136					
9R142					
9R224					
9R230					
9R236					
9R242					
24-30	Bevel-Pull Freestanding Lateral File	42			
24-36					
24-42					
26-30	Standard-Pull Freestanding Lateral File	25			
26-36					
26-42					
29P-3	Sloped-Pull Freestanding Lateral File	53			
29P-4					
29V-3					
29V-4					
C2A-3	Meridian® Low Credenza	71			
C2A-4					
C2K-3					
C2K-4					
EAP-L	EnhancedAccess™ Pull	93			
FSEL-	Meridian® Storage Surround Ends	84			
FSEV-					
FSLR-	Meridian® Storage Surround Support Legs	87			



20-Day or Less/Assigned Lead-Time Order Information

20-Day or Less and Assigned Lead-Time Programs

20-day or less and assigned lead-time products are designed for established Herman Miller dealers with pre-approved credit.

Products are distributed from multiple manufacturing facilities across the United States. All products and options not designated by an Assigned Lead-Time icon **A** will ship in 20 business days or less after being acknowledged by Herman Miller. Products and options designated by an **A** are on the assigned lead-time program and will ship in 20 days, less than 20 days, or more than 20 days from order acknowledgement.

Ordering Procedure

Please place orders through Order Manager. If this is not available to you, place orders through mail or fax. Verbal purchase orders will not be accepted.

Order Entry fax number for Passage®, 5000 Series, and Meridian® Filing and Storage: (616) 846 9236.

Order Entry fax number for all other products:
(616) 654 3085.

For more information, contact your Customer Care representative at:
(866) 854 3048 EXT 3400.

Shipments and Delivery

Per Herman Miller Terms and Conditions.

Changes and Cancellation

Per Herman Miller Terms and Conditions.



Keyed-Alike Information

Keyed-Alike Locks

All components with locks may be specified keyed alike. Products with keyed-alike locks will be shipped with lock chassis installed.

Installation of lock cylinders will be on-site according to instructions provided. Herman Miller, Inc., will not be responsible for lock cylinder installation.

When specifying product keyed-alike, include separate lines on your order for the lock cylinders.

For Action Office®, Ethospace®, Passage®, Quadrant®, Resolve®, and Supplemental products, list cylinder part number and key number (232092-XXX); select a key number (or numbers) between 226 and 427, excluding numbers 408 and 412.

The following products require a different lock cylinder part number. Specify UKY001-XXX for these products only; select a key number (or numbers) between 226 and 427, excluding numbers 408 and 412.

- A3013.
- A3053.
- G5180.
- G5181.
- G5280.

The keys provided in 232092-XXX and UKY001-XXX kits work with either cylinder type, provided the key numbers match.

For Tu® Storage, Canvas Office Landscape®, 5000 Series, and Meridian® Storage, see the following charts.

Keyed-alike locks are field installed.

To order keyed-alike locks for Action Office® Series 1 and 2 door panels, please contact Customer Care.

A master key can be used to open any lock on an attached or freestanding component. In addition, a removal key or lock change tool is required to remove lock plugs. Customers interested in ordering master keys, removal keys, or lock change tools should contact Customer Care.

For Canvas overhead and lower storage units, specify as follows:

Specification Code	Part Number	Color	Lock Series
KA	1B2JK7-XXX ¹	chrome	UM series 226-427

For Canvas Metal Storage, Meridian Storage, Tu Storage, and 5000 Series desk components with pedestals, specify as follows:

Specification Code	Key Number	Color	Lock Series
KA	232092-XXX ¹	black	UM series 226-427
KA	1B2JK7-XXX ¹	chrome	UM series 226-427

For 5000 Series flipper door unit with bezel or credenza storage cabinet with bezel, specify as follows:

Specification Code	Key Number	Color	Lock Series
KA	232092-XXX ¹	black	UM series 226-427

Key Number:

XXX¹ = a key number between 226 and 427 (excluding 408 and 412)

Vary Easy Program

Program Overview

Vary Easy is a program designed to help dealers specify standard products with a larger breadth of options. For example, depending on the type of product being specified, choices include additional size, finish, edge types, and cable management features. Vary Easy 3D, specIT, and third-party text-based specification packages support the Vary Easy program. Vary Easy 3D enables designers to create a 3D image, CAD symbols, and a price book page. A Vary Easy product number is assigned for each product as the user selects specific options. Once the product is completely specified, the order can be submitted via Kiosk's Order Manager or a dealer's business system.

Accessing and Specifying Vary Easy

To view the full product vocabulary, go to the Vary Easy Product Offering on Kiosk. To specify Vary Easy, go to the Vary Easy 3D website on Kiosk, specIT, or your third-party text-based specification package.

Once you've made your product line selection, continue to follow through each option and enter the specific options that represent the product you need. When the product is fully specified, Vary Easy will generate an orderable product number and instantly calculate a price.

Note: Failure to completely specify a product will cause a delay in order acknowledgements. Be sure to make a selection for all options offered.

The acknowledgement process for Vary Easy products is the same as for any standard order. Vary Easy products ship with a standardized lead time and are competitively priced.

For more information, contact your Customer Care Line at (866) 854 3048 EXT 3400.

Stain-to-Match Program

Stain-to-Match Program

Program Overview

The Stain-to-Match program gives you the option of using veneer finishes that are not listed in the standard offering. The program allows Herman Miller to match a customer's existing recut or natural veneer, or create a new finish that is unique to an installation.

Specific information on approval, ordering, pricing, and warranty for the Stain-to-Match program is listed below. Questions and requests for assistance may be directed to Herman Miller Options at:

(800) 654 3910

Ordering Products with Stain-to-Match Veneers

1. Fill out the Options Stain-to-Match Request Form and send along with a color sample (2" x 3" minimum) to the Herman Miller Options Applications Team at the address provided on the form. The form can be found on Omni.
2. Within 7-10 working days, Herman Miller Options will send a sample of the color-matched stain on Herman Miller veneer to the requester for the customer's signed approval.
3. If the sample meets the customer's approval, sign the reverse side of the sample, scan and email the approval to:
options@hermanmiller.com.
4. After the stain has been approved, a formal quotation with special number and pricing can be provided, or the product can be specified through the Vary Easy program, if available. Work with the Options team on final product needs and how to specify.
5. A purchase order can then be placed.

Stain-to-Match Warranty

Herman Miller warrants its products to be free from defects in craftsmanship from the date of delivery for the applicable warranty period. Herman Miller is responsible for the physical properties of the veneers available through the Stain-to-Match program, which include:

- STA: Stain-to-Match on Recut Ash
- STB: Stain-to-Match on Beech
- STC: Stain-to-Match on Cherry
- STD: Stain-to-Match on Oak
- STK: Stain-to-Match on Reltech Anigre (Geiger)
- STM: Stain-to-Match on Recut Mahogany
- STP: Stain-to-Match on Maple
- STU: Stain-to-Match on Walnut (Geiger)

See your specification tool for product specific finish offering limitations.



Customer's Own Material/ Customer's Own Leather Order Information — Cushion Tops

Customer's Own Material/Customer's Own Leather

Program Overview

The Customer's Own Material (COM) and Customer's Own Leather (COL) program gives you the option of using textiles other than those listed. Herman Miller will test textiles for application to Herman Miller products and will process orders for those with approved COM/COL textiles only. COM/COL are assigned lead time textiles.

Omni lists an overview of fabrics and leathers that have been tested and indicates whether or not they were approved for application to Herman Miller products.

Specific information on the terms and conditions, testing, approval, and ordering process for COM/COL is listed below. Questions about the COM/COL program and requests for assistance may be directed to your COM representative at:

(616) 654 3400

(866) 854 3048 EXT 6543400

Customer's Own Material/Customer's Own Leather Warranty

Herman Miller does not warrant COM/COL textiles. COM/COL textiles are tested for application only; they are not tested for performance. The Herman Miller warranty does apply to the underlying products.

Suppliers of COM/COL textiles are responsible for color consistency within commercial tolerances, UV stability, and resistance to soiling and perspiration.

Customer's Own Material/Customer's Own Leather Pricing

COM is a Category 1 fabric. There are no application charges for COM fabrics. COL is a Category 7 textile; refer to prices on specific products to determine the application charge.

Ordering and payment for COM/COL textile yardage are the responsibility of the customer and the textile supplier.

If desired, Herman Miller will purchase COM textiles directly from True Textiles, C.F. Stinson, Luna Textiles, Maharam, and Momentum Textiles to simplify ordering and shipment. For this service, refer to the Supplier Connection program.

Application Note

Herman Miller does not guarantee that Customer's Own Material (COM) fabric patterns will align across panels/tiles or from one screen to the next. We also do not guarantee that COM fabric designs will be positioned consistently in the same location across several panels, tiles, or screens.

Textile Approval

1. Select a COM/COL textile.
2. If your textile is not listed on Omni, obtain a test number from a COM representative at (616) 654 3400. You can also submit your request within Omni. Please have the following information ready before calling: textile name, number, pattern, and the product you will apply it to.
3. Herman Miller will notify you of approval or disapproval within 4 days from receipt of the test yardage.

Customer's Own Material/ Customer's Own Leather Order Information — Cushion Tops

continued

Ordering Products with COM/COL

1. Refer to the specific products to determine the yardage required for COM/COL textiles.
2. If your textile is not listed on Omni, call a COM representative at (616) 654 3400 or (866) 854 3048 EXT 6543400. The representative will assign an identification number for your textile (ID#) and will verify yardage requirements for your order. Yardage requirements are based on directional, 54"-wide textiles. Additional yardage may be needed due to the unique characteristics of a textile.
3. Enter your order on Order Manager in Omni.
4. Upon receipt of your purchase order, Herman Miller will send you a PO acknowledgment.
5. Arrangements must be made for the textiles to be shipped from the supplier to Herman Miller for application to the seating products. See Omni for shipping procedures and current shipping addresses or contact a COM representative at (616) 654 3400 or (866) 854 3048 EXT 6543400.

Products will be scheduled for production when COM/COL textiles are received at Herman Miller. Standard lead times in effect at that time will apply.

Note: If textiles are to be purchased directly by Herman Miller through the Supplier Connection program, Herman Miller will handle the ordering and shipping process and will schedule your order for production upon receipt of your purchase order (dependent on textile availability). Refer to the Supplier Connection program for more information.

Supplier Connection

Program Overview

The Supplier Connection program is a service offered by Herman Miller to purchase approved COM textiles directly from True Textiles, C.F. Stinson, Luna Textiles, Maharam, and Momentum Textiles. When you select a textile through this program, Herman Miller will facilitate the ordering, scheduling, and shipment of the textile directly with the supplier.

Suppliers included in the Supplier Connection program keep an active inventory of textiles that are pre-approved for application to Herman Miller products. Pre-approval applies only to the suitability of a textile for manufacturing and application to a Herman Miller product. Omni provides an overview of fabrics that have been tested and indicates whether or not they were approved for application to Herman Miller products.

Specific information on the terms and conditions, testing, approval, and ordering process for the Supplier Connection program is listed below. Questions and requests for assistance may be directed to your COM representative at:

(616) 654 3400
(866) 854 3048 EXT 6543400

Supplier Connection Warranty

Textiles purchased by Herman Miller through the Supplier Connection program are COM and are not warranted by Herman Miller. COM textiles are tested for application only; they are not tested for performance. The Herman Miller warranty does apply to the underlying products.

Suppliers of COM textiles are responsible for color consistency within commercial tolerances, UV stability, and resistance to soiling and perspiration.

Customer's Own Material/ Customer's Own Leather Order Information — Cushion Tops

continued

Supplier Connection Pricing

Textiles purchased by Herman Miller through the Supplier Connection program are COM. COM is a Category 1 fabric. There are no application charges for COM fabrics.

Payment for textiles purchased by Herman Miller through the Supplier Connection program is the responsibility of the customer or dealer. Herman Miller will invoice the order at the supplier's prices published at the time of the order.

Textile Approval

1. Refer to Omni to identify the approval status of the textile. If your textile is not listed, contact the COM Department to request testing for application to Herman Miller products.
2. Herman Miller will notify you of approval or disapproval in approximately 4 days from receipt of the test yardage. If the textile is approved, it will be assigned a COM identification number.

Ordering Products with Supplier Connection COM

1. Identify and include the following information on your purchase order:
 - Product number and option
 - Herman Miller's COM identification number
2. Enter your order on Order Manager in Omni.
3. Upon receipt of the purchase order, Herman Miller will process your order and send you a PO acknowledgment. Herman Miller will determine the yardage required to produce your product and will order and schedule for delivery the required textile. Standard lead times in effect at the time the textile is allocated at the supplier will apply to products ordered through this program.



Proprietary Textiles Application Chart — Seating

• Available

[A] Assigned lead-time textile.

See following page for exception notes.

[N] Non-woven textile.

	Aeron® Chairs	Cosm™ Chairs	Mirra® 2 Chairs/Stools	Celle® Chairs/Stools	Embody® Chairs	Sayl® Work Chairs/Stools	Sayl Side Chairs	Setu® Chairs/Stools	Setu Lounge Chair/Ottoman	Verus™ Work Chairs/Stools Back	Verus Work Chairs/Stools Seat	Verus Side Chairs Back	Verus Side Chairs Seat	Ergon 3® Chairs	Equa 2 Fully Upholstered Chairs/Stools	Equa 2 Split-Pad Upholstered Chairs/Stools	Aside® Chairs	Caper® Chairs/Stools	Celeste™ Seating	Keyn Chair Group Back	Keyn Chair Group Seat	Lino™ Chairs Back	Lino Chairs Seat	Locale® Bench Cushion	Public Office Landscape® Back	Public Office Landscape Seat	Plex™ Lounge Furniture	Swoop™ Lounge Seating - Fully Upholstered	Swoop Lounge Seating - Plywood	Eames Tandem Sling Seating	Cushion Tops	Workspaces			
Price Category 1																																			
COM Customers Own Material [A]			14			1	1							1	1	1	1		1		1			1			1	1	1	1	1	1	1	1	
231 8Z Pellicle®	•																																		
1A7 AireWeave™ 2		•																																	
3P ColorGuard [N]			15			•	22	•	•	•	•	•	•	2		3	8			•	•	•			•										
8T Crossing				•											•	•	•	•							•										
4RM Duo																							•												
6V Flexnet™																				•															
95 Gem			14					•	•						•	•	•	•							•										
845 Intercept		•																																	
65 Interweave																																			
4W Lyris 2™																																			
1MN Monologue			14			24	22	•	•																										
3DK Stretch Knit [A]						21																													
235 Tailored [A]				•		•	•	•	•	•	•	•	•																						
1WS Whisper			14			24	•	•	•	•	•	•	•																						
Price Category 2																																			
92 Crepe				•		•	•	•	•	•	•	•	•	•	•	•	•			•	•	•		•	•	•	•	•	•	•	•	•	•	•	
22Q Fish Net				•		•	•	•	•	•	•	•	•	•	•	•	•			•	•	•		•	•	•	•	•	•	•	•	•	•	•	
1LM Loom			14			•	•																												
1MW Marvel						21	22																												
1HA Medley			14	•		•	•	•	•	•	•	•	•	•	•	•	•																		
3A Moiré			14			•	•	•	•																										
30 Rhythm				•		•	•	•	•	•	•	•	•																						
1RV Rivet			14			21	22																												
8R Twist				•		•	•	•	•	•	•	•	•																						
22T Well Suited																	8																		
Price Category 3																																			
70 Bento						•	•	•	•	•	•	•	•	2	•	•	8					•	•											•	
8M Latitude™			23			•	•										3																		
22R Pins and Needles			14			•	•	•	•	•	•	•	•																						
8U Stitches				•		•	•	•	•	•	•	•	•																						
22V String Plaid			14			•	•	•	•	•	•	•	•																						
Price Category 4																																			
7Y Bingo [N]						•	•	•	•	•	•	•	•	2		3	8					•	•											•	
1DL Dialogue																																			
213 Mercer			14	•		21	22																												
1A9 Network																																			
6J Plateau																																			
6S Quilty			14			•	•																												
8Y Spools			14			21	•	•	•	•	•	•	•																						
22P Strata						•	•	•	•	•	•	•	•																						
Price Category 5																																			
14A Hopsak			14			•	•	•	•	•	•	•	•																						
22N Noble (22H) [A]			14			•	25	•																											
Price Category 6																																			
35 Balance				•																															
Price Category 7																																			
COL Customers Own Leather [A]	1		14											1	1	1	8																	1	
Price Category 8																																			
No fabrics available at this time																																			
Price Category 9																																			
21 Leather	23		14												•	•	8																	•	

continued on next page

Proprietary Textiles Application Chart — Seating

continued

• Available

[A] Assigned lead-time textile.

See below for exception notes.

[N] Non-woven textile.

Fire-Retardant Chairs/Fabrics

	Mirra® 2 Chairs/Stools with Butterfly Back	Celle® Chairs/Stools	Embody® Chairs	Sayl® Work Chairs/Stools	Sayl Side Chairs	Setu® Chairs/Stools	Setu Lounge Chair/Ottoman	Ergon 3® Chairs	Equa 2® Fully Upholstered Chairs/Stools	Equa 2 Split-Pad Upholstered Chairs/Stools	Aside® Chairs	Caper® Chairs/Stools	Celeste™ Seating	Plex™ Lounge Furniture	Swoop™ Lounge Seating - Fully Upholstered	Fames® Tandem Sling Seating
Price Category 1																
COM Customers Own Material [A]							1	1	1	1		1				
1A7__ AireWeave™ 2	•															
3P__ ColorGuard [N]		15	24	22				2		3	8				•	6
8T__ Crossing		14				•	•	•	•	•	•		•		•	
6V__ Flexnet™												•				
95__ Gem		14				•	•	•	•	•	•		•	•	•	
4W__ Lyris 2™							18	•								
235__ Tailored [A]	•					•							•	•		
Price Category 2																
92__ Crepe		14	•	•				•	•	•		•	•	•		
22Q__ Fish Net		•	•	•	•									•		
3A__ Moiré		14	•	•	•	•	•	•	•	•			•			
30__ Rhythm		14	24								8				•	
8R__ Twist		14	•	•	•	•	•			•	8		•	•	•	
Price Category 3																
70__ Bento				•	•	•	•	2	•		8				•	
8M__ Latitude™		•	•	•												
22R__ Pins and Needles				•	•	•										
8U__ Stitches		14	•	•	•	•	•	•	•	•			•	•	•	
22V__ String Plaid				•									•			
Price Category 4																
6J__ Plateau											•					
6S__ Quilty		14	•	•											•	
Price Category 5																
14A__ Hopsak		14	•				•	•	•	•				•	•	
Price Category 6																
35__ Balance			17													
Price Category 9																
21__ Leather		14									8					

All foam and Proprietary Textiles on HermanMiller seating comply with California TB 117-2013.

Application Note: Herman Miller cannot guarantee material/pattern alignment in adjacent products. For example, a fabric's pattern may not align from one pedestal cushion top to the next, or from one chair to another.

- 1 Refer to price book appendices and Omni for COM/COL information.
- 2 Available on all Ergon 3 chairs except for fabric back (FB) option.
- 3 Available on A- and B-size Equa 2 split-pad upholstered chairs.
- 4 See specific products for information on specifying leather in combination with fabric.
- 6 Only available in 3P02 Navy, 3P03 Spruce, 3P14 Black, 3P19 Slate, and 3PC7 Bucksuede.
- 8 Only available on nonupholstered outer back option (PB).
- 14 Available on Celle UC (upholstered seat) and HC (upholstered seat with protective edge) Chairs.
- 15 Available only on Celle HC (upholstered seat with protective edge) Chairs.
- 17 Only available in 3512 Carbon and 3513 Black.
- 18 Only available in 4W26 Slate Grey, 4W30 Java, and 4W31 Graphite.
- 21 Not available on Sayl upholstered back work chairs.
- 22 Not available on Sayl side chairs with upholstered backs.
- 23 Available in select colors. Refer to "Proprietary Textile Colors-Seating" for color offering.
- 24 Not available on Sayl upholstered High-Back Work Chairs.
- 25 Not available on Sayl side chairs with upholstered backs. Available in select colors. Refer to "Proprietary Textile Colors-Seating" for color offering.

Proprietary Textile Colors — Seating

Price Category 1

Customer's Own Material
See Order Information in
Appendices.
Assigned lead-time textile. A

8Z Pellicle®
For New Aeron® Chairs
56% elastomeric
44% polyester
23101 Mineral
23102 Carbon
23103 Graphite

AireWeave™ 2
For Mirra® 2 Chairs
67% elastomeric
33% antimony-free polyester
1A701 Alpine
1A702 Slate Grey
1A703 Graphite
1A704 Lime Green
1A705 Cappuccino
1A706 Urban Orange
1A707 Dark Turquoise
1A708 Twilight

ColorGuard
54" wide
100% vinyl
3P01 Grey
3P02 Navy *
3P03 Spruce * A
3P08 Blueberry A
3P12 Black Plum A
3P14 Black *
3P19 Slate *
3P31 Horizon Blue A
3P33 Pumice
3P54 Candy Apple A
3P72 Allspice A
3P96 Manzanita A
3P97 Fudge A
3PB2 Sea Grass A
3PB5 Vizcaya Palm A
3PB9 Neptune A
3PC7 Bucksuede * A
3PD4 Otter A

* Colors available on Eames®
Tandem Sling Seating.

A Assigned lead-time color.

Crossing
54" wide
86% antimony-free polyester
14% polyester
8T03 Wicker
8T04 Porcelain
8T05 Warm Grey
8T06 Sepia
8T07 Pumpkin
8T08 Copper
8T09 Cranberry
8T10 Tomato
8T11 Mulberry
8T12 Plum
8T13 Green Apple
8T14 Loden
8T15 Spruce
8T16 Periwinkle
8T17 Cerulean
8T18 Indigo
8T19 Shale
8T20 Brownstone
8T21 Bark
8T22 Tin
8T23 Graphite
8T24 Black

Duo
For Lino™ Chairs
52% polyester
48% elastomeric
4RM01 Mineral
4RM02 Poppy
4RM03 Green Leaf
4RM04 Jade
4RM05 Shadow
4RM06 Graphite

Flexnet™
For Caper® Chairs
69% elastomeric
31% polyester
6V01 Black
6V02 Silver Grey

Gem
54" wide
100% antimony-free polyester
9501 Sesame
9502 Tangerine
9503 Red
9504 Red Violet
9505 Mulberry
9506 Java
9507 Twilight
9508 Bayou
9509 Iris
9510 Berry Blue
9511 Aqua Green
9512 Green Apple
9513 Spruce
9514 Black
9515 Slate Grey
9516 Fog

Intercept
For Cosm™ Chairs
60% elastomeric
40% polyester
84501 Graphite
84502 Carbon
84503 Mineral
84504 Nightfall
84505 Glacier
84506 Canyon

Interweave
For Verus™ Chairs
71% elastomeric
29% polyester
6504 Pewter
6505 Charcoal
6506 Black

Price category 1 continued on
next page

Proprietary Textile Colors — Seating

continued

Price Category 1

continued

Appendix: Proprietary Textile Colors — Seating

Lyris 2™	
For Setu® Chairs	
74% elastomeric	
26% polyester	
4W21	Alpine
4W22	Mango
4W23	Chartreuse
4W25	Berry Blue
4W26	Slate Grey
4W28	Chino
4W29	Rattan
4W30	Java
4W31	Graphite

Monologue	
54" wide	
56% recycled polyester	
44% polyester	
1MN01	Linen
1MN02	Alabaster
1MN03	Truffle
1MN04	Folkstone
1MN05	Silver Pine
1MN06	Slate
1MN07	Seed
1MN08	Yellow Oxide
1MN09	Persimmon
1MN10	Tundra
1MN11	Meadow
1MN12	Blue Sky
1MN13	Blue Spruce
1MN14	Deep Sea

Stretch Knit	
Assigned lead-time textile. A	
Available only on Sayl®	
Suspension Back Work Chairs	
97% polyester, 3% spandex	
3DK01	Fog
3DK02	Slate Grey
3DK03	Java
3DK04	Black
3DK05	Red
3DK06	Green Apple
3DK07	Berry Blue

Tailored	
Assigned lead-time textile. A	
54" wide	
56% polyester	
44% recycled polyester	
23501	Studio White *
23502	Sugar *
23503	Tomato
23504	Orchid
23505	Boysenberry
23506	Chive
23507	Bluegrass
23508	Cobalt
23509	Cadet
23510	Fog
23511	Graphite
23512	Black
23513	Coffee

* Colors not available on Plex™ Lounge Furniture.

Whisper	
54" wide	
73% recycled polyester	
27% polyester	
1WS01	Sand Dollar
1WS02	Pebble
1WS03	Silver Birch
1WS04	Iceberg
1WS05	Silver Pine
1WS06	Carbon
1WS07	Cumin
1WS08	Adobe
1WS09	Strawberry
1WS10	Blush
1WS11	Eggplant
1WS12	Willow
1WS13	Sea Grass
1WS14	Pool
1WS15	Blueberry

Price Category 2

Crepe	
54" wide	
100% recycled polyester	
9201	Licorice
9203	Smoke
9207	Cherry
9209	Claret
9212	Raisin
9218	Aquamarine
9223	Cadet
9241	Beachglass
9243	Midnight
9244	Artichoke
9248	Warm White
9249	Stone
9250	Earth
9251	Fog
9252	Slate Grey
9253	Yellow Dark
9254	Coral
9255	Blush Grey
9256	Wild Berry
9257	Clover
9258	Caribbean
9259	Cerulean
9260	Brownstone
9261	Shale
9262	Graphite
9263	Tomato
9264	Green Apple

Fish Net	
55" wide	
100% recycled polyester	
22Q01	Oyster
22Q02	Stone
22Q03	Citrus
22Q04	Curry
22Q05	Chipotle
22Q06	Cherry
22Q07	Fuschia
22Q08	Claret
22Q09	Purple
22Q10	Clover
22Q11	Pesto
22Q12	Peacock
22Q13	Lagoon
22Q14	Twilight
22Q15	Bluestone
22Q16	Storm
22Q17	Black
22Q18	Cocoa

Loom	
54" wide	
100% polyester	
1LM01	Linen
1LM02	Brown Sugar and Spice
1LM03	Brick and Mortar
1LM04	Salt and Pepper
1LM05	Black
1LM06	Lemongrass
1LM07	Poppy
1LM08	Wild Berry
1LM09	Loden
1LM10	Jade
1LM11	Deep Sea

Price category 2 continued on next page

Proprietary Textile Colors — Seating

continued

Price Category 2

continued

Marvel	
54" wide	
100% pvc-free polyurethane	
1MV01	Summer White
1MV02	Sand Dollar
1MV03	Espresso
1MV04	Folkstone Grey
1MV05	Graphite
1MV06	Onyx
1MV07	Polar Blue
1MV08	Blush Grey
1MV09	Woodrose
1MV10	Citrus
1MV11	Adobe
1MV12	Red
1MV13	Kiwi Green
1MV14	Pine
1MV15	Teal Green
1MV16	Twilight

Medley	
54" wide	
100% polyester	
1HA01	Stone
1HA02	Trail
1HA03	Charcoal
1HA04	Cinder
1HA05	Citrus
1HA06	Papaya
1HA07	Chutney
1HA08	Tundra
1HA09	Feather Grey
1HA10	Chartreuse
1HA11	Loden
1HA12	Peacock
1HA13	Bayou
1HA14	Blue Grotto
1HA15	Blueberry
1HA22	Khaki
1HA23	Pewter
1HA24	Yellow Oxide
1HA25	Vintage Rose
1HA26	Raspberry
1HA27	Acai Berry

Moiré	
54" wide	
100% recycled polyester	
3A01	Concrete
3A02	Biscotti
3A03	Rattan
3A04	Chambray
3A05	Fern
3A08	Violet
3A09	Zin
3A10	Curry
3A11	Spice
3A12	Cork

Rhythm	
54" wide	
100% polyester	
3001	Kiwi Green *
3002	Green Apple
3003	Peacock
3004	Bayou *
3005	Berry Blue
3006	Iris
3007	Twilight
3008	Pumpkin *
3009	Poppy *
3010	Molasses
3011	Mulberry
3012	Khaki *
3013	Mink
3014	Black
3015	Charcoal

* Colors not available on Embody® Chair.

Rivet	
54" wide	
100% recycled polyester	
1RV01	Twig
1RV02	Deep Clay
1RV03	Woodrose
1RV04	Otter
1RV05	Hemlock
1RV06	Olive
1RV07	Lagoon
1RV08	Deep Sea
1RV09	Charcoal
1RV10	Grey Brindle

Twist	
54" wide	
80% antimony-free polyester	
13% recycled polyester	
7% polyester	
8R05	Wicker
8R10	Poppy
8R14	Tin
8R15	Shale
8R16	Graphite
8R17	Birch
8R18	Sepia
8R22	Blueberry
8R23	Green Apple
8R26	Gunmetal
8R27	Cinder
8R28	Citrus
8R29	Pekoe
8R30	Tangerine
8R31	Red Plum
8R32	Wisteria
8R33	Forest
8R34	Jade Dark
8R35	Waterfall
8R36	Midnight Blue
8R37	Carbon Dark

Price category 2 continued on next page

Proprietary Textile Colors — Seating

continued

Appendix: Proprietary Textile Colors — Seating

Price Category 2

continued

Well Suited	
55" wide	
79% polyester	
21% recycled polyester	
22T01	Oyster *
22T02	Raffia *
22T03	Peppermint *
22T04	Wild Berry *
22T05	Spring Green *
22T06	Mint *
22T07	Periwinkle *
22T08	Cool Grey *
22T09	Citrus *
22T10	Pumpkin
22T11	Red
22T12	Fuschia
22T13	Orchid
22T14	Chartreuse *
22T15	Green Apple
22T16	Jade
22T17	Peacock
22T18	Blueberry
22T19	Bluestone *
22T20	Mink

* Colors not available on Swoop™ Plywood Lounge Seating.

Price Category 3

Bento	
54" wide	
100% antimony-free polyester	
7001	Frost
7002	Linen
7003	Khaki
7004	Truffle
7005	Grey Black
7006	Pumpkin
7007	Cranberry
7008	Everglade
7009	Cobalt
Latitude™	
61" wide	
100% polyester	
8M01	Graphite
8M02	Shadow
8M10	Alpine
8M17	Black
8M21	Slate Grey
8M22	Lime Green
8M23	French Press
8M24	Urban Orange
8M25	Dark Turquoise
8M26	Twilight
Latitude	
Colors for Mirra 2 Chairs	
100% polyester	
8M10	Alpine
8M17	Black
8M21	Slate Grey
8M22	Lime Green
8M23	French Press
8M24	Urban Orange
8M25	Dark Turquoise
8M26	Twilight

Pins and Needles	
58" wide	
76% recycled polyester	
24% polyester	
22R01	Day and Night
22R02	Night and Day
Stitches	
54" wide	
54% polyester	
46% recycled polyester	
8U02	Rye
8U03	Khaki
8U04	Honey
8U05	Cattail
8U08	Cool Grey
8U09	Slate Blue
8U11	Evening Blue
8U12	Charcoal
8U13	Kiwi Green
8U16	Cocoa
8U17	Seed

String Plaid	
54" wide	
100% recycled polyester	
22V01	Warm White on Khaki
22V02	Mint on Yellow Green
22V03	Mist on Blue Grey
22V04	Sky Blue on Red
22V05	Lime on Magenta
22V06	Bright Green on Green
22V07	Aqua Blue on Cerulean
22V08	Ivory on Black

Price Category 4

Bingo	
54" wide	
100% PVC-free polyurethane	
Resilience® finish	
7Y01	Oyster
7Y02	Natural
7Y03	Cashew
7Y05	Rattan
7Y06	Root
7Y07	Woodland
7Y10	Allspice
7Y11	Canyon
7Y17	Seed
7Y18	Mushroom
7Y19	Blue Grey
7Y21	Black
7Y22	Mint
7Y23	Seaport
7Y24	Evening Blue
7Y26	Kiwi Green
7Y27	Celadon
7Y29	Pesto

Price category 4 continued on next page

Proprietary Textile Colors — Seating

continued

Price Category 4

continued

Dialogue

For Public Office Landscape®
Sectional Back/Social Chair Back
knit to size
100% polyester

1DL01 Light Brindle

1DL02 Dark Brindle

Mercer

54" wide
50% solution dyed recycled nylon
50% solution dyed nylon
BLOCKaide

21301 Stone

21303 Cayenne

21305 Pesto

21306 Teal Blue

21307 Ultramarine

21310 Charcoal

Network

For Public Office Landscape®
Sectional Back/Social Chair Back
knit to size
100% polyester

1A901 Warm White

1A902 Fog

1A903 Red

1A904 Wildberry

1A905 Green Apple

1A906 Twilight

1A907 Graphite

Plateau

Perspectives® Collection

knit to size
100% polyester

6J01 Feather Grey

6J02 Trail

6J06 Twig

6J08 Sagebrush

6J09 Winter Berry

6J10 Thunder

6J11 Blueberry

6J12 Rosemary

6J14 Black

Quilty

56" wide
100% antimony-free polyester
GreenShield

6S03 Khaki

6S04 Straw

6S07 Brick

6S10 Mink

6S11 Green Apple

6S13 Indigo

6S14 Zinc

6S15 Slate

6S16 Beachwood

6S17 Paprika

6S18 Plum

6S19 Juniper

6S20 Grey Black

Spools

54" wide
51% recycled polyester
49% polyester
Crypton® Green

8Y03 Trail

8Y05 Copper

8Y08 Bluegrass

8Y09 Lagoon

8Y11 Beachglass

8Y12 Marsh

8Y13 Bud

Strata

54" wide
50% solution dyed recycled nylon
50% solution dyed nylon
BLOCKaide

22P04 Pesto

22P05 Peacock

22P06 Blue Jay

22P07 Blueberry

22P09 Mango

22P10 Paprika

22P12 Wheat

22P13 Brownstone

22P14 Bayou

Price Category 5

Hopsak

56" wide
100% recycled polyester

14A20 Black

14A22 Raw Umber Dark

14A26 Grey Blue Dark

14A30 Sepia Dark

14A38 Emerald Dark

14A39 Yellow Dark

14A40 Orange

14A41 Sienna

14A42 Olive Green Dark

14A43 Crimson

14A44 Crimson Dark Dark

14A45 Violet Dark

14A46 Pink Dark Dark

14A47 Ultramarine Dark

14A48 Cobalt Blue

14A49 Terra Cotta

14A50 Ochre Dark

Noble

Assigned lead-time textile. ^A

54" wide

100% wool

22N02 Chipotle *

22N04 Cherry *

22N07 Cadet *

22N08 Berry Blue *

22N09 Peacock *

22N11 Pesto *

22N12 Blue Grey Mix *

22H15 Heathered Black **

22H16 Heathered Grey **

22H17 Heathered Twilight **

22H18 Heathered Rye Grass **

22N19 Lemongrass Mix *

22H20 Heathered Red **

22H21 Heathered Wild Berry **

22N22 Pesto Mix *

22N23 Lagoon Mix *

* Colors not available on Sayl® Side Chairs.

** Colors not available on Sayl Side Chairs Back.

Proprietary Textile Colors — Seating

continued

Appendix: Proprietary Textile Colors | Seating

Price Category 6

Balance

For Embody® chairs
100% polyester

3506	Green Apple
3507	Blue Moon
3509	Berry Blue
3510	Iris
3512	Carbon
3513	Black

Price Category 7

Customer's Own Leather

See Order Information in
Appendices. Assigned lead-time
textile. A

Price Category 8

No fabrics available at this time.

Price Category 9

Leather

approx. 50 sq. ft. per hide
100% leather

2101	Ivory
2109	Black *
2110	Smoke
2111	Graphite
2112	Khaki
2113	Rattan
2114	Truffle
2115	Alpine
2116	Haze
2117	Sable Grey
2118	Dark Mineral **
2119	Dark Carbon ***
2120	Cranberry
2121	Deep Sea

* Armpad color available on
Aeron® Chair, Graphite.
** Armpad color available on
Aeron Chair, Mineral.
*** Armpad color available on
Aeron Chair, Carbon.

Maharam® Application Chart — Seating

- Available

See below for exception notes.

Maharam textiles are on assigned lead times. A

[N] Non-woven textile.

	Mirra® Chairs/Stools	Celle® Chairs	Sayl® Work Chairs/Stools	Sayl Side Chairs	Setu® Chairs/Stools	Setu Lounge Chair/Ottoman	Verus™ Work Chairs/Stools Back	Verus Work Chairs/Stools Seat	Verus Side Chairs Back	Verus Side Chairs Seat	Ergon 3® Chairs	Equa 2® Fully Upholstered Chairs/Stools	Equa 2 Split-Pad Upholstered Chairs/Stools	Aside® Chairs	Caper® Chairs/Stools	Celeste™ Seating	Keyn Chair Group Back	Keyn Chair Group Seat	Lino™ Chairs Seat	Locale® Bench Cushions	Public Office Landscape® Seat	Plex™ Lounge Furniture	Swoop™ Lounge Seating - Fully Upholstered	Swoop Lounge Seating - Plywood	Cushion Tops	Workspaces		
Price Category 1-2																												
No fabrics available at this time.																												
Price Category 3																												
ZM2__ Meld - Maharam	14	•	•	•	•	•	•	•	•	•	•	•	•	•	•	•	•	•	•	•	•	•	•	•	•	•	•	
Price Category 4-9																												
No fabrics available at this time.																												
Price Category A																												
No fabrics available at this time.																												
Price Category B																												
VM__ Medium - Maharam	14	•	•				•	•			•	•	•	•	•	•	•	•					•	•	•	•	•	
TI__ Messenger - Maharam *	14	•	•	•	•	•	•	•	•	•		•	•		•	•	•	•	•				•	•	•	•	•	
Price Category C																												
ZLR__ Lariat - Maharam [N]	14	•	•				•	•									•	•				•	20			•		
Z27__ Manner - Maharam	14	•	•				•	•	•	•	•	•	•		•	•	•	•	•				•	•	•	•	•	
Z3__ Metric - Maharam	14	•	•				•	•	•	•	•	•	•		•	•	•	•	•				•	•	•	•	•	
Price Category D																												
ZMD__ Mode - Maharam	14	18	•				•	•	•			•	•				•	•	•	•	•	•	•	•	•	•	•	
Price Category E																												
ZFS__ Focus - Maharam	14	16	16									•					•									•		
VgG__ Ledger - Maharam [N]	14	18	16				•	•	•								•	•	•							•		
ZBQ__ Oblique - Maharam			16				•	•	•	•		•					•	•	•				•	•	•			
ZP2__ Pick - Maharam		18	•				•	•	•	•		•					•	•	•				•	•	•			
Z32__ Skein - Maharam	14	16	16	•								•					•	•	•							•	•	
ZT3__ Technic - Maharam	14	18	•									•					•	•	•									
Price Category F																												
ZCH__ Chock - Maharam			•									•																
ZC8__ Coin - Maharam	14	•	16									•					•									•		
ZCJ__ Coincide - Maharam		16	•														•									•		
VS__ Crush - Maharam				•	•											•							•			•		
ZD1__ Disc - Maharam	14	18	16									•					•	•	•							•		
ZD3__ Divide - Maharam	14	18	•									•					•	•	•							•		
ZEE__ Exchange - Maharam	14	18	16				•	•				•					•	•	•			20				•		
Z29__ Plait - Maharam	14	16	•				•	•	•								•	•	•				•	•	•	•	•	
V26__ Remix - Maharam		16	16														•	•	•			•	•	•	•	•	•	
ZRV__ Rove - Maharam	14	16	•				•	•									•	•	•									
ZRA__ Runner Standard - Maharam	14	18	•														•	•	•									
ZSM__ Seam - Maharam	14	•	•									•					•	•	•									
Z31__ Sequence - Maharam	14	•	•				•					•	•				•	•	•				•	•		•	•	
ZSS__ Shuttle Standard - Maharam	14	•	•														•	•	•									
Z33__ Strum - Maharam [N]			16														•	•	•				•					
ZWX__ Waxen - Maharam	14	16	•																									

* Available in select colors on 20-day lead-time.
Refer to "Maharam Colors - Seating" for 20-day colors.

continued on next page

Maharam® Application Chart — Seating *continued*

- Available

See below for exception notes.

Maharam textiles are on assigned lead times. A

[N] Non-woven textile.

	Mirra® Chairs/Stools	Celle® Chairs	Sayl® Work Chairs/Stools	Sayl Side Chairs	Setu® Chairs/Stools	Setu Lounge Chair/Ottoman	Verus™ Work Chairs/Stools Back	Verus Work Chairs/Stools Seat	Verus Side Chairs Back	Verus Side Chairs Seat	Ergon 3® Chairs	Equa 2® Fully Upholstered Chairs/Stools	Equa 2 Split-Pad Upholstered Chairs/Stools	Aside® Chairs	Caper® Chairs/Stools	Celeste™ Seating	Keyn Chair Group Back	Keyn Chair Group Seat	Lino™ Chairs Seat	Locale® Bench Cushions	Public Office Landscape® Seat	Plex™ Lounge Furniture	Swoop™ Lounge Seating - Fully Upholstered	Swoop Lounge Seating - Plywood	Cushion Tops	Workspaces	
Price Category G																											
ZC9__ Coin Crypton - Maharam			•	16			•																				
ZCF__ Coincide High Performance - Maharam	14	16	16				•		•				•					•									
ZCQ__ Colline - Maharam																											
ZC2__ Compound - Maharam [N]			16	16			•		•	•		•	8									•		•			
ZD2__ Disc Crypton - Maharam	14	16	16																								
ZD4__ Divide Crypton - Maharam	14	16	•																								
Z23__ Divina MD - Maharam	14	•	16	•		•	•	•	•	•	•	•	•			•	•	•	•			•		•	•		
TF__ Divina - Maharam	14	•	•	•	•	•	•	•	•	•	•	•	•	8		•	•	•	•			•	•	•	•		
TG__ Divina Melange - Maharam	14	•	•	•	•	•	•	•	•	•	•	•	•	8		•	•	•	•			•	•	•	•		
ZEM__ Emboss - Maharam [N]	14	16	16																								
ZF1__ Fold - Maharam [N]	14	16	16																								
ZH1__ Hero by Kvadrat - Maharam	14	•	16			•	•	•	•																		
ZQM__ Omen - Maharam	14	18	16																								
ZP1__ Pick Crypton - Maharam	14	16	•																								
ZP3__ Pocket - Maharam	14		•				•		•															•		•	
ZRG__ Ring - Maharam	14	16	16																								
ZRF__ Runner - Maharam	14	16	16																								•
ZSN__ Sheen - Maharam	14	18	•			•	•		•																		
ZSE__ Steelcut - Maharam			•	•			•		•													•					
V25__ Steelcut Trio - Maharam	14	16	•													•		•				•				•	
ZS1__ Stride - Maharam	14	•	•																								
ZT4__ Ticker - Maharam	14	•	•				•		•																	•	•
ZVT__ Vestige - Maharam	14	18	•																								
Price Category H																											
ZT__ Circles - Maharam	14	16	16													•		•									•
ZS__ Crosspatch - Maharam	14		•													•		•									•
Z2D__ Ditto - Maharam	14	•	16													•		•					•			•	
ZK__ Dot Pattern - Maharam	14	•	•	•	•		•		•			•	•	•	•	•	•	•									•
Z24__ Hallingdal - Maharam	14	•	•	•		•	•	•	•	•	•	•	•			•		•	•			•		•		•	
ZQF__ Offset - Maharam	14	16	•													•		•								•	
ZL__ Small Dot Pattern - Maharam	14	•	•	•	•		•		•							•		•									•
ZTN__ Tonus - Maharam			16	16																		•					
Price Category I																											
ZLC__ Latch - Maharam		14	•	•			•		•					•					•								
ZT2__ Teatro - Maharam			•	•			•		•																		
Price Category J																											
ZT1__ Tokyo - Maharam																						•					
Price Category K																											
ZC7__ Coda by Kvadrat - Maharam		14	16	16												•										•	•
Price Category L																											
ZMK__ Minicheck - Maharam		14	•	•												•			•	•							
ZPF__ Plait High Performance - Maharam		14	16	•																							
Price Category M																											
ZF2__ Fruit - Maharam		14		16												•											
Price Category N-Z																											
No fabrics available at this time.																											

3 Available on A- and B-size Equa 2 split-pad upholstered chairs.

8 Only available on nonupholstered outer back option (PB).

14 Available on Celle UC (upholstered seat) and HC (upholstered seat with protective edge) chairs.

16 Available on Sayl Chair seat.

18 Available on Sayl Chair seat and upholstered mid-back.

20 Not available on Plex Club Chair with Headrest.

Maharam® Colors — Seating

Price Category 1-2

No fabrics available at this time.

Price Category 3

Meld – Maharam	
54" wide	
68% post-consumer recycled polyester	
32% polyester	
PFOA-Free stain resistant	
ZM201/466387-201	Vast
ZM202/466387-202	Panda
ZM203/466387-203	Skyline
ZM204/466387-204	Knight
ZM205/466387-205	Quill
ZM206/466387-206	Pipe
ZM207/466387-207	Grate
ZM208/466387-208	Gloss
ZM209/466387-209	Bulb
ZM210/466387-210	Bride
ZM211/466387-211	Stark
ZM212/466387-212	Seashell
ZM213/466387-213	Antler
ZM214/466387-214	Crater
ZM215/466387-215	Perennial
ZM216/466387-216	Mulberry
ZM217/466387-217	Fuchsia
ZM218/466387-218	Amethyst
ZM219/466387-219	Merlot
ZM220/466387-220	Magma
ZM221/466387-221	Rooster
ZM222/466387-222	Heat
ZM223/466387-223	Clementine
ZM224/466387-224	Fox
ZM225/466387-225	Kiss
ZM226/466387-226	Bare
ZM227/466387-227	Blonde
ZM228/466387-228	Mimosa
ZM229/466387-229	Comet
ZM230/466387-230	Honeydew
ZM231/466387-231	Wild
ZM232/466387-232	Vine
ZM233/466387-233	Seed
ZM234/466387-234	Kale

Meld continued	
ZM235/466387-235	Waterfall
ZM236/466387-236	Nordic
ZM237/466387-237	Reef
ZM238/466387-238	Wave
ZM239/466387-239	Isle
ZM240/466387-240	Creek
ZM241/466387-241	Mariner
ZM242/466387-242	Globe
ZM243/466387-243	Spa

Price Category 4-9

No fabrics available at this time.

- Maharam textiles are on assigned lead times **A** unless otherwise noted.
- Fabric numbers are listed as Herman Miller fabric number/Maharam fabric number.

Maharam® Colors — Seating

continued

Price Category A

No fabrics available at this time.

Price Category B

Medium – Maharam

54" wide

100% polyester

VM01/463490-001	Raven
VM02/463490-002	Smoke
VM03/463490-003	Alloy
VM04/463490-004	Flax
VM06/463490-006	Bark
VM07/463490-007	Espresso
VM08/463490-008	Pecan
VM12/463490-012	Pumpkin
VM13/463490-013	Persimmon
VM14/463490-014	Laser
VM16/463490-016	Port
VM22/463490-022	Marina
VM29/463490-029	Pistachio
VM32/463490-032	Prospect
VM36/463490-036	Delight
VM39/463490-039	Nautical
VM40/463490-040	Pool
VM44/463490-044	Washed
VM45/463490-045	Sculpture
VM46/463490-046	Thatched
VM47/463490-047	Hike
VM48/463490-048	Tangle
VM49/463490-049	Pacific
VM50/463490-050	Cosmic
VM51/463490-051	Cascade
VM52/463490-052	Blackberry
VM53/463490-053	Nasturtium
VM54/463490-054	Wooded

Messenger – Maharam

54" wide

78% recycled polyester

15% polyester, 7% nylon

TI01/458640-001	Balsa
TI06/458640-006	Tobacco
TI07/458640-007	Shadow *
TI08/458640-008	Bayou *
TI10/458640-010	Zinc
TI24/458640-024	Poppy
TI25/458640-025	Mao
TI29/458640-029	Onyx
TI31/458640-031	Cloud *
TI38/458640-038	Depth *
TI40/458640-040	Nile
TI41/458640-041	Azure *
TI45/458640-045	Cactus *
TI46/458640-046	Ice *
TI48/458640-048	Neon *
TI50/458640-050	Hydrangea *
TI51/458640-051	Lilac
TI52/458640-052	Chestnut
TI53/458640-053	Tangelo
TI54/458640-054	Lumine *
TI58/458640-058	Snow
TI59/458640-059	Fennel
TI60/458640-060	Peridot *
TI61/458640-061	Capri
TI62/458640-062	Ultramarine
TI63/458640-063	Squall
TI66/458640-066	Cassis
TI67/458640-067	Aster
TI68/458640-068	Spice
TI69/458640-069	Cherry
TI70/458640-070	Vibrant
TI71/458640-071	Satsuma *
TI72/458640-072	Maize

Messenger continued

TI76/458640-076	Fossil
TI77/458640-077	Ash
TI78/458640-078	Tusk
TI79/458640-079	Oyster
TI80/458640-080	Pensive
TI81/458640-081	Husk
TI82/458640-082	Fireside
TI83/458640-083	Chili
TI84/458640-084	Robust
TI85/458640-085	Beyond
TI86/458640-086	Voyage
TI87/458640-087	Everglade
TI88/458640-088	Electric

* Colors available on 20-day lead time.

- Maharam textiles are on assigned lead times A unless otherwise noted.
- Fabric numbers are listed as Herman Miller fabric number/Maharam fabric number.

Maharam® Colors — Seating

continued

Price Category C

Lariat – Maharam	
54" wide	
100% vinyl	
ZLR01/440401-001	001
ZLR02/440401-002	002
ZLR03/440401-003	003
ZLR04/440401-004	004
ZLR06/440401-006	006
ZLR07/440401-007	007
ZLR08/440401-008	008
ZLR10/440401-010	010
ZLR11/440401-011	011
ZLR12/440401-012	012
ZLR13/440401-013	013
ZLR14/440401-014	014
ZLR15/440401-015	015
ZLR16/440401-016	016
ZLR18/440401-018	018
ZLR20/440401-020	020
ZLR21/440401-021	021
ZLR23/440401-023	023
ZLR24/440401-024	024
ZLR25/440401-025	025
ZLR26/440401-026	026
ZLR27/440401-027	027
ZLR28/440401-028	028
ZLR29/440401-029	029
ZLR30/440401-030	030
ZLR31/440401-031	031
ZLR32/440401-032	032
ZLR33/440401-033	033
ZLR34/440401-034	034
ZLR35/440401-035	035
ZLR36/440401-036	036
ZLR37/440401-037	037
ZLR38/440401-038	038

Manner - Maharam	
54" wide	
100% recycled polyester	
Z2701/466177-001	Magic
Z2702/466177-002	Carob
Z2703/466177-003	Porpoise
Z2704/466177-004	Flint
Z2705/466177-005	Hush
Z2706/466177-006	Nuance
Z2707/466177-007	Thicket
Z2708/466177-008	Cocoa
Z2709/466177-009	Pathway
Z2710/466177-010	Cola
Z2711/466177-011	Ember
Z2712/466177-012	Wagon
Z2713/466177-013	Ablaze
Z2714/466177-014	Peel
Z2715/466177-015	Penny
Z2716/466177-016	Butterscotch
Z2717/466177-017	Harvest
Z2718/466177-018	Lioness
Z2719/466177-019	Caper
Z2720/466177-020	Parakeet
Z2721/466177-021	Greenway
Z2722/466177-022	Aquatic
Z2723/466177-023	Cottage
Z2724/466177-024	Dahlia
Z2725/466177-025	Vivid
Z2726/466177-026	Basin
Z2727/466177-027	Schooner

Metric – Maharam	
54" wide	
51% recycled polyester	
49% polyester	
Z301/466014-001	Phantom
Z302/466014-002	Fog
Z303/466014-003	Fleece
Z304/466014-004	Sourdough
Z305/466014-005	Toffee
Z306/466014-006	Driftwood
Z307/466014-007	Mineral
Z308/466014-008	Bittersweet
Z309/466014-009	Arabica
Z310/466014-010	Cerise
Z311/466014-011	Brick
Z312/466014-012	Cardinal
Z313/466014-013	Lava
Z314/466014-014	Oriole
Z315/466014-015	Cedar
Z317/466014-017	Caramel
Z318/466014-018	Pollen
Z319/466014-019	Tupelo
Z320/466014-020	Alligator
Z321/466014-021	Envy
Z322/466014-022	Bonsai
Z323/466014-023	Tar
Z324/466014-024	Anchor
Z325/466014-025	Twilight
Z326/466014-026	Admiral
Z327/466014-027	Seaport
Z328/466014-028	Scuba

Price Category D

Mode – Maharam	
54" wide	
80% post-consumer recycled polyester	
20% polyester	
PFOA-Free stain resistant finish	
ZMD01/466337-001	Stroll
ZMD02/466337-002	Intaglio
ZMD03/466337-003	Ominous
ZMD04/466337-004	Machine
ZMD05/466337-005	Talus
ZMD06/466337-006	Marsh
ZMD07/466337-007	Hollow
ZMD08/466337-008	Sycamore
ZMD09/466337-009	Clavicle
ZMD10/466337-010	Billygoat
ZMD11/466337-011	Spindle
ZMD12/466337-012	Lemon
ZMD13/466337-013	Oxeye
ZMD14/466337-014	Henge
ZMD15/466337-015	Goldenrod
ZMD16/466337-016	Cottontail
ZMD17/466337-017	Lioness
ZMD18/466337-018	Oriole
ZMD19/466337-019	Rust
ZMD20/466337-020	Carotene
ZMD21/466337-021	Blush
ZMD22/466337-022	Vermillion
ZMD23/466337-023	Alder
ZMD24/466337-024	Kermes
ZMD25/466337-025	Barberry
ZMD26/466337-026	Petal
ZMD27/466337-027	Valley
ZMD28/466337-028	Odyssey
ZMD29/466337-029	Ballpoint
ZMD30/466337-030	Toile
ZMD31/466337-031	Paradise
ZMD32/466337-032	Angelfish
ZMD33/466337-033	Denim

Price category D continued on next page

- Maharam textiles are on assigned lead times A unless otherwise noted.
- Fabric numbers are listed as Herman Miller fabric number/Maharam fabric number.

Maharam® Colors — Seating

continued

Price Category D

continued

Mode continued

ZMD34/466337-034	Crush
ZMD35/466337-035	Jetty
ZMD36/466337-036	Saltwater
ZMD37/466337-037	Mallard
ZMD38/466337-038	Celtic
ZMD39/466337-039	Eucalyptus
ZMD40/466337-040	Bonsai
ZMD41/466337-041	Sassafras
ZMD42/466337-042	Yucca
ZMD43/466337-043	Lichen

Focus - Maharam

57" wide	
54% post-industrial recycled polyester	
33% polyester	
13% post-consumer recycled polyester	
ZFS01/465910-001	Ivory
ZFS02/465910-002	Allow
ZFS04/465910-004	Lichen
ZFS06/465910-006	Sierra
ZFS07/465910-007	Merlot
ZFS08/465910-008	Clove
ZFS09/465910-009	Carbon
ZFS10/465910-010	Regatta
ZFS11/465910-011	Emerald

Ledger – Maharam

54" wide	
100% polyurethane	
V9G1/463770-001	001
V9G2/463770-002	002
V9G3/463770-003	003
V9G4/463770-004	004
V9G6/463770-006	006
V9G7/463770-007	007
V9GG/463770-017	017
V9GH/463770-018	018
V9GJ/463770-019	019
V9GK/463770-020	020
V9GM/463770-022	022
V9GQ/463770-025	025
V9GS/463770-026	026
V9GT/463770-027	027
V9GU/463770-028	028
V9GV/463770-029	029
V9GW/463770-030	030
V9GX/463770-031	031
V9GY/463770-032	032
V9GZ/463770-033	033
V9G10/463770-034	034
V9G11/463770-035	035
V9G12/463770-036	036
V9G13/463770-037	037
V9G14/463770-038	038

.....

Ledger continued

V9G15/463770-039	039
V9G16/463770-040	040
V9G17/463770-041	041
V9G18/463770-042	042
V9G19/463770-043	043
V9G20/463770-044	044
V9G21/463770-045	045
V9G22/463770-046	046

Oblique - Maharam

58" wide	
100% polyester	
with stain resistant finish	
ZBQ01/466222-001	001
ZBQ02/466222-002	002
ZBQ03/466222-003	003
ZBQ04/466222-004	004
ZBQ05/466222-005	005
ZBQ06/466222-006	006
ZBQ07/466222-007	007

Pick - Maharam

58" wide	
100% polyester	
with stain resistant finish	
ZP201/466224-001	001
ZP202/466224-002	002
ZP203/466224-003	003
ZP204/466224-004	004
ZP205/466224-005	005
ZP206/466224-006	006
ZP207/466224-007	007
ZP208/466224-008	008
ZP209/466224-009	009
ZP210/466224-010	010

.....

Skein - Maharam

54" wide	
56% recycled polyester	
44% polyester	
Z3201/466170-001	Burrow
Z3204/466170-004	Sumac
Z3205/466170-005	Pomegranate
Z3206/466170-006	Cavern
Z3207/466170-007	Bitter
Z3208/466170-008	Cinder
Z3209/466170-009	Dock
Z3210/466170-010	Cadet
Z3211/466170-011	Marsh

Technic - Maharam

56" wide	
60% post-industrial recycled polyester	
40% post-consumer recycled polyester	
PFOA-Free stain resistant finish	
Acrylic backing	
ZT301/466226-001	Cumin
ZT302/466226-002	Evergreen
ZT303/466226-003	Cobalt
ZT304/466226-004	Bear
ZT305/466226-005	Squirrel

.....

- Maharam textiles are on assigned lead times **A** unless otherwise noted.
- Fabric numbers are listed as Herman Miller fabric number/Maharam fabric number.

Maharam® Colors — Seating

continued

Price Category F

Chock - Maharam	
59" wide	
36% rayon	
35% cotton	
29% solution-dyed post-industrial recycled nylon	
PFOA-Free stain resistant finish	
Acrylic backing	
ZCH01/466219-001	Beige
ZCH02/466219-002	Stone
ZCH03/466219-003	Brown
ZCH04/466219-004	Red
ZCH05/466219-005	Copper
ZCH07/466219-007	Smoke
ZCH08/466219-008	Ebony

Coin - Maharam	
57" wide	
43% polyester	
37% post-industrial recycled polyester	
20% post-consumer recycled polyester	
PFOA-Free stain resistant finish	
Acrylic backing	
ZC801/466233-001	Nickel
ZC802/466233-002	Diner
ZC803/466233-003	Copper
ZC804/466233-004	Maroon
ZC805/466233-005	Penny
ZC806/466233-006	Exchange
ZC807/466233-007	Lead

Coincide - Maharam	
54" wide	
100% polyester	
ZCJ01/465808-001	Mist
ZCJ02/465808-002	Drizzle
ZCJ03/465808-003	Cicada
ZCJ04/465808-004	Bungalow
ZCJ05/465808-005	Aurora
ZCJ06/465808-006	Currant
ZCJ07/465808-007	Raisin
ZCJ08/465808-008	Tranquil
ZCJ09/465808-009	Caribbean
ZCJ10/465808-010	Woodland
ZCJ11/465808-011	Acre

Crush - Maharam	
54" wide	
85% solution-dyed nylon	
13% polyester	
2% polyolefin	
VS01/464780-001	001
VS02/464780-002	002
VS05/464780-005	005
VS08/464780-008	008
VS13/464780-013	013
VS16/464780-016	016
VS17/464780-017	017
VS18/464780-018	018
VS19/464780-019	019
VS20/464780-020	020
VS22/464780-022	022
VS23/464780-023	023
VS26/464780-026	026
VS27/464780-027	027

Disc - Maharam	
57" wide	
100% polyester	
PFOA-Free stain resistant finish	
Acrylic backing	
ZD101/466221-001	Nude
ZD102/466221-002	Khaki
ZD103/466221-003	Festive
ZD104/466221-004	Vibrant
ZD105/466221-005	Somber
ZD106/466221-006	Warm
ZD107/466221-007	Steel

Divide - Maharam	
57" wide	
45% polyester	
36% post-industrial recycled polyester	
19% post-consumer recycled polyester	
PFOA-Free stain resistant finish	
Acrylic backing	
ZD301/466220-001	Ecru
ZD302/466220-002	Café
ZD303/466220-003	Concrete
ZD304/466220-004	Forest
ZD305/466220-005	Tropic
ZD306/466220-006	Lagoon
ZD307/466220-007	Mocha
ZD308/466220-008	Singe
ZD309/466220-009	Cayenne

Exchange - Maharam	
58" wide	
58% post-industrial recycled polyester	
42% post-consumer recycled polyester	
ZEE01/466027-001	Cinder
ZEE02/466027-002	Sable
ZEE04/466027-004	Gull
ZEE06/466027-006	Coastline
ZEE07/466027-007	Clay
ZEE08/466027-008	Buck
ZEE10/466027-010	Rhubarb
ZEE11/466027-011	Punch

Plait - Maharam	
58" wide	
68% recycled polyester	
32% polyester	
Z2901/466052-001	Cobblestone
Z2902/466052-002	Sachet
Z2903/466052-003	Mesa
Z2904/466052-004	Tavern
Z2905/466052-005	Sequoia
Z2906/466052-006	Rhubarb
Z2907/466052-007	Sangria
Z2908/466052-008	Reef
Z2909/466052-009	Stormy
Z2910/466052-010	Dapper

Remix - Maharam	
54" wide	
90% wool	
10% nylon	
V2601/465956-113	113
V2602/465956-123	123
V2603/465956-133	133
V2604/465956-143	143
V2605/465956-152	152
V2606/465956-163	163
V2607/465956-173	173
V2608/465956-183	183
V2609/465956-223	223
V2610/465956-233	233
V2611/465956-242	242
V2612/465956-252	252
V2613/465956-362	362
V2614/465956-373	373
V2615/465956-383	383
V2616/465956-393	393
V2617/465956-412	412
V2618/465956-422	422
V2619/465956-433	433
V2620/465956-443	443
V2621/465956-452	452
V2622/465956-543	543
V2623/465956-612	612

Price category F continued on next page

- Maharam textiles are on assigned lead times ^A unless otherwise noted.
- Fabric numbers are listed as Herman Miller fabric number/Maharam fabric number.

Maharam® Colors — Seating

continued

Price Category F

continued

Remix continued	
V2624/465956-632	632
V2625/465956-643	643
V2626/465956-653	653
V2627/465956-662	662
V2628/465956-672	672
V2629/465956-682	682
V2630/465956-692	692
V2631/465956-722	722
V2632/465956-733	733
V2633/465956-743	743
V2634/465956-753	753
V2635/465956-762	762
V2636/465956-773	773
V2637/465956-783	783
V2638/465956-823	823
V2639/465956-842	842
V2640/465956-852	852
V2641/465956-873	873
V2642/465956-912	912
V2643/465956-923	923
V2644/465956-933	933
V2645/465956-942	942
V2646/465956-962	962
V2647/465956-973	973
V2648/465956-982	982
V2649/465956-954	954

Rove - Maharam	
54" wide	
100% solution-dyed polyolefin with silver-based antimicrobial	
ZRV01/466096-001	Rice
ZRV02/466096-002	Soba
ZRV03/466096-003	Owl
ZRV04/466096-004	Till
ZRV05/466096-005	Dijon
ZRV06/466096-006	Mum
ZRV07/466096-007	Nasturtium
ZRV08/466096-008	Vixen
ZRV09/466096-009	Roast
ZRV10/466096-010	Llama
ZRV11/466096-011	Rind
ZRV12/466096-012	Grackle
ZRV13/466096-013	Indigo
ZRV14/466096-014	Drip
ZRV15/466096-015	Neptunia
ZRV16/466096-016	Pomelo
ZRV17/466096-017	Fairy

Runner Standard - Maharam	
58" wide	
57% post-industrial recycled polyester	
43% post-consumer recycled polyester	
ZRA07/466167-007	Bluff
ZRA08/466167-008	Arid
ZRA09/466167-009	Grove
ZRA10/466167-010	Starboard
ZRA11/466167-011	Plot
ZRA12/466167-012	Carousel

Seam - Maharam	
54" wide	
100% polyester	
PFOA-Free stain resistant finish	
Acrylic backing	
ZSM01/466289-001	Reed
ZSM02/466289-002	Console
ZSM03/466289-003	Play
ZSM04/466289-004	Jock
ZSM05/466289-005	Engine
ZSM06/466289-006	Haunted
ZSM07/466289-007	Transmit
ZSM08/466289-008	Spark
ZSM09/466289-009	Storm
ZSM10/466289-010	Tunnel

Sequence - Maharam	
54" wide	
100% solution-dyed polyolefin with silver-based antimicrobial	
Z3101/466179-001	Driftwood
Z3102/466179-002	Boardwalk
Z3103/466179-003	Rattan
Z3104/466179-004	Alfresco
Z3105/466179-005	Plunge
Z3106/466179-006	Starboard
Z3107/466179-007	Veranda
Z3108/466179-008	Lodge
Z3109/466179-009	Flare

Shuttle Standard - Maharam	
54" wide	
84% post-industrial recycled polyester	
16% post-consumer recycled polyester	
ZSS16/466168-016	Clam
ZSS17/466168-017	Plateau
ZSS18/466168-018	Shoal

Strum - Maharam	
54" wide	
100% polyurethane with silver-based antimicrobial	
Z3301/466122-001	Overcast
Z3302/466122-002	Ridge
Z3303/466122-003	Twilight
Z3304/466122-004	Pigeon
Z3305/466122-005	Char
Z3306/466122-006	Cabin
Z3307/466122-007	Bur
Z3308/466122-008	Abalone
Z3309/466122-009	Prawn
Z3310/466122-010	Gourd
Z3311/466122-011	Wheat
Z3312/466122-012	Lemongrass

Waxen - Maharam	
54" wide	
100% polyester	
ZWX01/466078-001	Appear
ZWX03/466078-003	Savanna
ZWX05/466078-005	Frozen
ZWX06/466078-006	Highland
ZWX07/466078-007	Patina
ZWX10/466078-010	Ruby
ZWX11/466078-011	Ember
ZWX12/466078-012	Harvest
ZWX14/466078-014	Fresh
ZWX16/466078-016	Jay
ZWX17/466078-017	Gazer
ZWX19/466078-019	Bayou

- Maharam textiles are on assigned lead times **A** unless otherwise noted.
- Fabric numbers are listed as Herman Miller fabric number/Maharam fabric number.

Maharam® Colors — Seating

continued

Price Category G

Coin Crypton - Maharam	
54" wide	
43% polyester	
37% post-industrial recycled polyester	
20% post-consumer recycled polyester	
Crypton Green finish and backing	
ZC901/466236-001	Nickel
ZC902/466236-002	Diner
ZC903/466236-003	Copper
ZC904/466236-004	Maroon
ZC905/466236-005	Penny
ZC906/466236-006	Exchange
ZC907/466236-007	Lead

Coincide High Performance-Maharam	
54" wide	
100% polyester	
ZCF02/466132-002	Drizzle
ZCF03/466132-003	Cicada
ZCF04/466132-004	Bungalow
ZCF07/466132-007	Raisin
ZCF10/466132-010	Woodland
ZCF11/466132-011	Acre

Colline - Maharam	
55" wide	
75% wool	
17% acrylic	
8% nylon	
ZCQ01/466155-108	108
ZCQ02/466155-118	118
ZCQ03/466155-148	148
ZCQ04/466155-188	188
ZCQ05/466155-228	228
ZCQ06/466155-348	348
ZCQ07/466155-448	448
ZCQ08/466155-548	548
ZCQ09/466155-568	568
ZCQ10/466155-668	668
ZCQ11/466155-688	688
ZCQ12/466155-788	788

Compound - Maharam	
54" wide	
100% polyurethane	
silane-based antimicrobial	
ZC201/466196-001	001
ZC202/466196-002	002
ZC203/466196-003	003
ZC204/466196-004	004
ZC205/466196-005	005
ZC206/466196-006	006
ZC207/466196-007	007
ZC208/466196-008	008
ZC209/466196-009	009
ZC210/466196-010	010
ZC211/466196-011	011
ZC212/466196-012	012
ZC213/466196-013	013
ZC214/466196-014	014
ZC215/466196-015	015
ZC216/466196-016	016
ZC217/466196-017	017
ZC218/466196-018	018
ZC219/466196-019	019

Disc Crypton - Maharam	
57" wide	
100% polyester	
Crypton finish and backing	
ZD204/466237-004	Vibrant
ZD205/466237-005	Somber
ZD207/466237-007	Steel

Divide Crypton - Maharam	
57" wide	
45% polyester	
36% post-industrial recycled polyester	
19% post-consumer recycled polyester	
Crypton Green finish and backing	
ZD401/466238-001	Ecru
ZD402/466238-002	Café
ZD403/466238-003	Concrete
ZD404/466238-004	Forest
ZD405/466238-005	Tropic
ZD406/466238-006	Lagoon
ZD407/466238-007	Mocha
ZD408/466238-008	Singe

Divina MD - Maharam	
59" wide	
100% wool	
Z2301/466150-193	193
Z2302/466150-203	203
Z2303/466150-213	213
Z2304/466150-293	293
Z2305/466150-343	343
Z2306/466150-353	353
Z2307/466150-363	363
Z2308/466150-413	413
Z2309/466150-433	433
Z2310/466150-453	453
Z2311/466150-613	613
Z2312/466150-633	633
Z2313/466150-653	653
Z2314/466150-673	673
Z2315/466150-683	683
Z2316/466150-713	713
Z2317/466150-733	733
Z2318/466150-743	743
Z2319/466150-753	753
Z2320/466150-773	773
Z2321/466150-783	783
Z2322/466150-813	813
Z2323/466150-843	843
Z2324/466150-873	873
Z2325/466150-913	913
Z2326/466150-943	943
Z2327/466150-973	973

Divina - Maharam	
59" wide	
100% wool	
TF01/460730-154	154
TF03/460730-171	171
TF04/460730-173	173
TF05/460730-181	181
TF06/460730-191	191
TF08/460730-224	224
TF10/460730-334	334
TF13/460730-384	384
TF14/460730-393	393
TF16/460730-444	444
TF17/460730-462	462
TF18/460730-542	542

- Maharam textiles are on assigned lead times ^A unless otherwise noted.
- Fabric numbers are listed as Herman Miller fabric number/Maharam fabric number.

Price category G continued on next page

Maharam® Colors – Seating

continued

Price Category G

continued

Divina continued	
TF19/460730-552	552
TF20/460730-562	562
TF22/460730-584	584
TF23/460730-623	623
TF25/460730-652	652
TF26/460730-662	662
TF27/460730-671	671
TF29/460730-684	684
TF30/460730-691	691
TF31/460730-692	692
TF33/460730-712	712
TF37/460730-742	742
TF41/460730-782	782
TF42/460730-791	791
TF43/460730-793	793
TF47/460730-893	893
TF49/460730-922	922
TF51/460730-944	944
TF53/460730-984	984
TF55/460730-106	106
TF56/460730-236	236
TF57/460730-246	246
TF58/460730-346	346
TF59/460730-356	356
TF60/460730-376	376
TF61/460730-426	426
TF62/460730-526	526
TF63/460730-536	536
TF64/460730-626	626
TF65/460730-636	636
TF66/460730-666	666
TF67/460730-676	676
TF68/460730-686	686
TF69/460730-696	696
TF70/460730-756	756
TF71/460730-826	826
TF72/460730-836	836
TF73/460730-846	846
TF74/460730-856	856
TF75/460730-876	876
TF76/460730-886	886
TF77/460730-936	936
TF78/460730-956	956
TF79/460730-966	966

Divina Melange — Maharam	
59" wide	
100% wool	
TG01/460830-120	120
TG02/460830-170	170
TG03/460830-180	180
TG04/460830-220	220
TG05/460830-260	260
TG06/460830-280	280
TG07/460830-871	871
TG08/460830-821	821
TG09/460830-771	771
TG10/460830-721	721
TG11/460830-731	731
TG12/460830-681	681
TG13/460830-631	631
TG15/460830-671	671
TG16/460830-581	581
TG17/460830-531	531
TG18/460830-521	521
TG19/460830-571	571
TG20/460830-421	421
TG21/460830-471	471
TG22/460830-931	931
TG24/460830-971	971
TG25/460830-925	925
TG26/460830-620	620

Emboss - Maharam	
54" wide	
100% polyurethane	
Polyester backing	
ZEM01/466281-001	Bronze
ZEM02/466281-002	Brass
ZEM03/466281-003	Gold
ZEM04/466281-004	Platinum
ZEM05/466281-005	Silver
ZEM06/466281-006	Aqua
ZEM07/466281-007	Aegean
ZEM08/466281-008	Cobalt
ZEM09/466281-009	Ultraviolet
ZEM10/466281-010	Copper
ZEM11/466281-011	Molten

Fold - Maharam	
54" wide	
100% polyurethane	
Polyester backing	
ZF101/466292-001	Jet
ZF102/466292-002	Chalk
ZF103/466292-003	Smoke
ZF104/466292-004	Putty
ZF105/466292-005	Fatigue
ZF106/466292-006	Splash
ZF107/466292-007	Apple
ZF108/466292-008	Moss
ZF109/466292-009	Graphite
ZF110/466292-010	Midnight

Hero by Kvadrat - Maharam	
55" wide	
96% wool	
4% nylon	
ZH101/466318-101	101
ZH102/466318-141	141
ZH103/466318-151	151
ZH104/466318-181	181
ZH105/466318-191	191
ZH106/466318-201	201
ZH107/466318-211	211
ZH108/466318-231	231
ZH109/466318-311	311
ZH110/466318-381	381
ZH111/466318-411	411
ZH112/466318-441	441
ZH113/466318-451	451
ZH114/466318-481	481
ZH115/466318-511	511
ZH116/466318-541	541
ZH117/466318-551	551
ZH118/466318-601	601
ZH119/466318-681	681
ZH120/466318-701	701
ZH121/466318-711	711

Hero by Kvadrat continued	
ZH122/466318-751	751
ZH123/466318-791	791
ZH124/466318-901	901
ZH125/466318-931	931
ZH126/466318-941	941
ZH127/466318-981	981
ZH128/466318-991	991

Omen - Maharam	
54" wide	
75% polyester	
16% post-industrial recycled polyester	
9% post-consumer recycled polyester	
ZQM01/466172-001	Clam
ZQM02/466172-002	Pewter
ZQM03/466172-003	Hazel
ZQM04/466172-004	Grain
ZQM05/466172-005	Bundle
ZQM07/466172-007	Glacier
ZQM08/466172-008	Surf
ZQM09/466172-009	Wade
ZQM10/466172-010	Marble
ZQM11/466172-011	Silt
ZQM12/466172-012	Persimmon
ZQM13/466172-013	Rocket

Pick Crypton - Maharam	
54" wide	
100% polyester	
Crypton finish and backing	
ZP102/466235-002	Olive
ZP103/466235-003	Slate
ZP104/466235-004	Espresso
ZP105/466235-005	Pepper
ZP106/466235-006	Masala
ZP107/466235-007	Fresh
ZP108/466235-008	Cool
ZP109/466235-009	Ink
ZP110/466235-010	Jet

Price category G continued on next page

- Maharam textiles are on assigned lead times **A** unless otherwise noted.
- Fabric numbers are listed as Herman Miller fabric number/Maharam fabric number.

Maharam® Colors — Seating

continued

Price Category G

continued

Pocket - Maharam	
54" wide	
76% recycled polyester	
24% nylon	
ZP301/466243-001	001
ZP302/466243-002	002
ZP303/466243-003	003
ZP304/466243-004	004
ZP305/466243-005	005
ZP306/466243-006	006
ZP307/466243-007	007

Ring - Maharam	
54" wide	
48% polyester	
34% post-industrial recycled polyester	
18% post-consumer recycled polyester	
ZRG02/466182-002	Flax
ZRG04/466182-004	Black
ZRG05/466182-005	Scarlet
ZRG06/466182-006	Rust
ZRG07/466182-007	Green
ZRG09/466182-009	Royal

Runner - Maharam	
54" wide	
57% post-industrial recycled polyester	
43% post-consumer recycled polyester	
ZRF01/466108-001	Bluff
ZRF02/466108-002	Arid
ZRF03/466108-003	Grove
ZRF04/466108-004	Starboard
ZRF05/466108-005	Plot
ZRF06/466108-006	Carousel

Sheen - Maharam	
54" wide	
100% polyurethane with silane-based antimicrobial	
ZSN01/466246-001	Sail
ZSN02/466246-002	Silver
ZSN03/466246-003	Pewter
ZSN04/466246-004	Hearth
ZSN05/466246-005	Fern
ZSN06/466246-006	Bog
ZSN07/466246-007	Cricket
ZSN08/466246-008	Clove
ZSN09/466246-009	Mystic
ZSN10/466246-010	Vat
ZSN11/466246-011	Huckleberry
ZSN12/466246-012	Mauve
ZSN13/466246-013	Brick
ZSN14/466246-014	Ruby
ZSN15/466246-015	Dragon
ZSN16/466246-016	Kumquat
ZSN17/466246-017	Cinnamon
ZSN18/466246-018	Alder
ZSN21/466246-021	Bronze

Steelcut - Maharam	
55" wide	
90% wool	
10% nylon	
ZSE01/464470-110	110
ZSE02/464470-120	120
ZSE03/464470-135	135
ZSE04/464470-140	140
ZSE05/464470-155	155
ZSE06/464470-160	160
ZSE07/464470-180	180
ZSE08/464470-190	190
ZSE09/464470-220	220
ZSE10/464470-240	240
ZSE11/464470-255	255
ZSE12/464470-265	265
ZSE13/464470-365	365
ZSE14/464470-370	370
ZSE15/464470-380	380
ZSE16/464470-435	435
ZSE17/464470-445	445
ZSE18/464470-535	535
ZSE19/464470-545	545
ZSE20/464470-550	550
ZSE21/464470-605	605
ZSE22/464470-615	615
ZSE23/464470-625	625
ZSE24/464470-635	635
ZSE25/464470-655	655
ZSE26/464470-660	660
ZSE27/464470-685	685
ZSE28/464470-695	695
ZSE29/464470-760	760
ZSE30/464470-775	775
ZSE31/464470-780	780
ZSE32/464470-820	820
ZSE33/464470-835	835
ZSE34/464470-935	935
ZSE35/464470-950	950
ZSE36/464470-975	975
ZSE37/464470-985	985

Steelcut Trio - Maharam	
55" wide	
90% wool	
10% nylon	
V2501/465906-105	105
V2502/465906-113	113
V2503/465906-124	124
V2504/465906-133	133
V2506/465906-153	153
V2507/465906-195	195
V2508/465906-205	205
V2509/465906-213	213
V2513/465906-253	253
V2514/465906-283	283
V2518/465906-383	383
V2523/465906-453	453
V2525/465906-515	515
V2526/465906-533	533
V2527/465906-553	553
V2529/465906-645	645
V2534/465906-713	713
V2542/465906-865	865
V2543/465906-883	883
V2544/465906-915	915
V2545/465906-933	933
V2546/465906-945	945
V2547/465906-953	953
V2548/465906-965	965
V2549/465906-983	983
V2550/465906-176	176
V2551/465906-226	226
V2552/465906-236	236
V2553/465906-246	246
V2554/465906-266	266
V2555/465906-276	276
V2556/465906-336	336
V2557/465906-376	376
V2558/465906-416	416
V2559/465906-426	426
V2560/465906-436	436
V2561/465906-446	446

Appendix: Maharam Colors — Seating

Price category G continued on next page

- Maharam textiles are on assigned lead times A unless otherwise noted.
- Fabric numbers are listed as Herman Miller fabric number/Maharam fabric number.

Maharam® Colors — Seating

continued

Price Category G

continued

Steelcut Trio <i>continued</i>	
V2562/465906-466	466
V2563/465906-476	476
V2564/465906-506	506
V2565/465906-526	526
V2566/465906-576	576
V2567/465906-616	616
V2568/465906-636	636
V2569/465906-666	666
V2570/465906-686	686
V2571/465906-716	716
V2572/465906-746	746
V2573/465906-756	756
V2574/465906-776	776
V2575/465906-796	796
V2576/465906-806	806
V2577/465906-906	906
V2578/465906-916	916
V2579/465906-946	946
V2580/465906-966	966
V2581/465906-976	976
V2582/465906-996	996

Stride - Maharam	
58" wide	
40% post-industrial recycled polyester	
39% polyester	
21% post-consumer recycled polyester	
PFOA-Free stain resistant finish	
Acrylic backing	
ZS103/466252-003	Midnight
ZS104/466252-004	Moss
ZS106/466252-006	Ember

Ticker - Maharam	
54" wide	
47% polyester	
31% post-industrial recycled polyester	
22% post-consumer recycled polyester	
Crypton green finish and backing	
ZT401/466304-001	Calm
ZT402/466304-002	Millet
ZT403/466304-003	Sow
ZT404/466304-004	Beaver
ZT405/466304-005	Patch
ZT406/466304-006	Balloon
ZT407/466304-007	Squad
ZT408/466304-008	Bale
ZT409/466304-009	Fecund
ZT410/466304-010	Aquarium
ZT411/466304-011	Drink
ZT412/466304-012	Depth
ZT413/466304-013	Far

Vestige - Maharam	
54" wide	
71% polyester	
29% rayon	
ZVT01/466259-001	001
ZVT02/466259-002	002
ZVT03/466259-003	003
ZVT04/466259-004	004
ZVT05/466259-005	005
ZVT06/466259-006	006
ZVT07/466259-007	007
ZVT08/466259-008	008
ZVT09/466259-009	009
ZVT10/466259-010	010

Price Category H

Circles — Maharam	
55" wide	
70% cotton	
30% polyester	
ZT01/458310-001	Khaki
ZT02/458310-002	Fatigue
ZT03/458310-003	Document
ZT04/458310-004	Engine
ZT05/458310-005	Charcoal

Crosspatch — Maharam	
54" wide	
75% rayon	
25% polyester	
ZS01/458920-001	Song
ZS02/458920-002	Fresh
ZS04/458920-004	Document
ZS06/458920-006	Circus
ZS08/458920-008	Grounded

Ditto — Maharam	
54" wide	
77% recycled polyester	
23% solution dyed nylon	
Z2D1/465993-001	Nacre
Z2D2/465993-002	Shadow
Z2D3/465993-003	Saddle
Z2D9/465993-009	Fern
Z2DA/465993-010	Fountain
Z2DB/465993-011	Cobalt
Z2DC/465993-012	Iron
Z2DD/465993-013	Driftwood

Dot Pattern — Maharam	
55" wide	
71% cotton	
29% polyester	
ZK01/458300-001	Document
ZK02/458300-002	Taupe
ZK04/458300-004	Red
ZK05/458300-005	Navy

Hallingdal - Maharam	
51" wide	
70% wool	
30% rayon	
Z2401/460760-100	100
Z2402/460760-103	103
Z2403/460760-110	110
Z2404/460760-113	113
Z2405/460760-116	116
Z2406/460760-123	123
Z2407/460760-126	126
Z2408/460760-130	130
Z2409/460760-143	143
Z2410/460760-153	153
Z2411/460760-166	166
Z2412/460760-173	173
Z2413/460760-180	180
Z2414/460760-190	190
Z2415/460760-200	200
Z2416/460760-220	220
Z2417/460760-224	224
Z2418/460760-227	227
Z2419/460760-270	270
Z2420/460760-350	350
Z2421/460760-368	368
Z2422/460760-370	370
Z2423/460760-376	376
Z2424/460760-390	390
Z2425/460760-407	407
Z2426/460760-420	420
Z2427/460760-457	457
Z2428/460760-526	526
Z2429/460760-547	547
Z2430/460760-563	563
Z2431/460760-573	573
Z2432/460760-590	590
Z2433/460760-596	596
Z2434/460760-600	600
Z2435/460760-657	657
Z2436/460760-660	660
Z2437/460760-674	674
Z2438/460760-680	680
Z2439/460760-687	687

Price category H continued on next page

- Maharam textiles are on assigned lead times **A** unless otherwise noted.
- Fabric numbers are listed as Herman Miller fabric number/Maharam fabric number.

Maharam® Colors — Seating

continued

Price Category H

continued

Hallingdal continued

Z2440/460760-694	694
Z2441/460760-702	702
Z2442/460760-723	723
Z2443/460760-733	733
Z2444/460760-750	750
Z2445/460760-753	753
Z2446/460760-754	754
Z2447/460760-763	763
Z2448/460760-764	764
Z2449/460760-773	773
Z2450/460760-810	810
Z2451/460760-840	840
Z2452/460760-850	850
Z2453/460760-890	890
Z2454/460760-907	907
Z2455/460760-944	944
Z2456/460760-960	960
Z2457/460760-968	968
Z2458/460760-980	980

Offset – Maharam

54" wide	
40% cotton	
36% nylon	
24% wool	
ZQF01/465951-001	Passage
ZQF02/465951-002	Fieldstone
ZQF03/465951-003	Coast
ZQF04/465951-004	Esplanade
ZQF05/465951-005	Oasis
ZQF06/465951-006	Spice
ZQF07/465951-007	Bloom

Small Dot Pattern — Maharam

55" wide	
71% cotton	
29% polyester	
ZL01/458320-001	Document
ZL02/458320-002	Sand
ZL03/458320-003	Khaki
ZL04/458320-004	Taupe
ZL05/458320-005	Charcoal
ZL06/458320-006	Document
Reverse	
ZL07/458320-007	Red
ZL08/458320-008	Yellow
ZL09/458320-009	Green

Tonus - Maharam

51" wide	
90% wool	
10% helanka	
ZTN01/460800-100	100
ZTN03/460800-109	109
ZTN05/460800-118	118
ZTN10/460800-125	125
ZTN13/460800-128	128
ZTN14/460800-129	129
ZTN15/460800-130	130
ZTN16/460800-131	131
ZTN17/460800-132	132
ZTN19/460800-135	135
ZTN21/460800-207	207
ZTN23/460800-210	210
ZTN26/460800-216	216
ZTN27/460800-240	240
ZTN29/460800-440	440
ZTN32/460800-508	508

Tonus continued

ZTN34/460800-605	605
ZTN35/460800-608	608
ZTN36/460800-609	609
ZTN37/460800-610	610
ZTN38/460800-613	613
ZTN40/460800-615	615
ZTN41/460800-619	619
ZTN51/460800-631	631
ZTN54/460800-634	634
ZTN56/460800-636	636
ZTN59/460800-690	690
ZTN62/460800-840	840
ZTN63/460800-940	940
ZTN65/460800-224	224
ZTN66/460800-244	244
ZTN67/460800-364	364
ZTN68/460800-374	374
ZTN69/460800-394	394
ZTN70/460800-424	424
ZTN71/460800-454	454
ZTN72/460800-464	464
ZTN73/460800-474	474
ZTN74/460800-554	554
ZTN75/460800-654	654
ZTN76/460800-664	664
ZTN77/460800-684	684
ZTN78/460800-754	754
ZTN79/460800-764	764
ZTN80/460800-854	854
ZTN81/460800-914	914
ZTN82/460800-934	934
ZTN83/460800-954	954
ZTN84/460800-964	964
ZTN85/460800-974	974

Price Category I

Latch - Maharam

55" wide	
61% cotton	
39% solution-dyed post-industrial recycled nylon	
16% rayon	
PFOA-Free stain resistant finish	
Acrylic backing	
ZLC01/466301-001	Rescue
ZLC02/466301-002	Guide
ZLC03/466301-003	Rotary
ZLC04/466301-004	Radar
ZLC05/466301-005	Sphere
ZLC06/466301-006	Solemn

Teatro - Maharam

55" wide	
100% polyester	
Polyester/Cotton backing	
ZT201/466309-001	Crumb
ZT202/466309-002	Dorper
ZT203/466309-003	Herd
ZT204/466309-004	Deep
ZT205/466309-005	Robe
ZT206/466309-006	Heat
ZT207/466309-007	Caspian
ZT208/466309-008	Misty
ZT209/466309-009	Boulder
ZT210/466309-010	Elixir
ZT211/466309-011	Guard
ZT212/466309-012	Throne

Appendix: Maharam Colors — Seating

- Maharam textiles are on assigned lead times ^A unless otherwise noted.
- Fabric numbers are listed as Herman Miller fabric number/Maharam fabric number.

Maharam® Colors — Seating

continued

Appendix: Maharam Colors — Seating

Price Category J

Tokyo - Maharam	
59" wide	
67% wool	
24% polyester	
9% nylon	
ZT101/466247-112	112
ZT102/466247-132	132
ZT103/466247-182	182
ZT104/466247-242	242
ZT105/466247-252	252
ZT106/466247-352	352
ZT107/466247-432	432
ZT108/466247-632	632
ZT109/466247-652	652
ZT110/466247-682	682
ZT111/466247-692	692
ZT112/466247-732	732
ZT113/466247-782	782
ZT114/466247-952	952
ZT115/466247-982	982

Price Category K

Coda by Kvadrat - Maharam	
55" wide	
90% wool	
10% nylon	
ZC701/464480-100	100
ZC702/464480-103	103
ZC703/464480-116	116
ZC704/464480-182	182
ZC705/464480-222	222
ZC706/464480-232	232
ZC707/464480-242	242
ZC708/464480-362	362
ZC709/464480-382	382
ZC710/464480-410	410
ZC711/464480-422	422
ZC712/464480-442	442
ZC713/464480-610	610
ZC714/464480-632	632
ZC715/464480-642	642
ZC716/464480-722	722
ZC717/464480-762	762
ZC718/464480-962	962

Price Category L

Minicheck - Maharam	
55" wide	
78% cotton	
22% polyester	
PFOA-Free stain resistant finish	
ZMK01/466268-001	Black/White

Plait High Performance - Maharam	
58" wide	
53% post-industrial polyester	
32% polyester	
15% post-consumer recycled polyester	
ZPF02/466138-002	Sachet
ZPF05/466138-005	Sequoia
ZPF08/466138-008	Reef

Price Category M

Fruit - Maharam	
54" wide	
55% cotton	
32% nylon	
13% post-consumer recycled polyester	
PFOA-Free stain resistant finish	
Acrylic backing	
ZF201/466262-001	Opal
ZF202/466262-002	Lime
ZF203/466262-003	Olive
ZF204/466262-004	Sky
ZF205/466262-005	Kernal
ZF206/466262-006	Droplet
ZF207/466262-007	Russet

- Maharam textiles are on assigned lead times A unless otherwise noted.
- Fabric numbers are listed as Herman Miller fabric number/Maharam fabric number.

Maharam® Colors — Seating

continued

Price Category N-Z

No fabrics available at this time.

- Maharam textiles are on assigned lead times **A** unless otherwise noted.
- Fabric numbers are listed as Herman Miller fabric number/Maharam fabric number.

For more information about our products and services or to see a list of dealers, please visit us at HermanMiller.com or call (800) 851 1196.

© 2018 Herman Miller, Inc., Zeeland, Michigan

® **HermanMiller**, 3D Intelligent, AO, Action Office, Aeron, ArcSpan, Aside, Avall, Avive, Bubble Lamps, Canvas Office Landscape, Caper, Celle, Co/Struc, Daisiyone, Distil, Eames, Eco-Dematerialized, Embody, Envelop, Equa 2, Ergon 3, Ethospace, Exclave, Fine-Tune, FlexFront, Flo, Formcoat, Formwork, Ground Cloth, Herman Miller for the Home, Herman Miller for Healthcare, Intersect, Kinemat, Lapjack, Layout Studio, Lifework, Limerick, Live Unframed, Living Office, Locale, Maharam, Meridian, Mirra, Passage, Pellicle, Perspectives, PostureFit, Public Office Landscape, Resolve, Rodney, Sayl, Setu, Thrive, Tu, Wishbone, and Y-Tower are among the registered trademarks of Herman Miller, Inc., and its owned subsidiaries.

™ 8Z Pellicle, About Face, AireWeave, Albert, Backfit, Bubbletack, Burdick Group, Butterfly Back, Celeste, Cellular Suspension, Clam, Compass, Connect, Cosm, Cubert, DOT, Duracare, Durawrap, Eames Soft Pad, EnhancedAccess, Everywhere, Flex-Edge, Flute, Harmonic, Herman Miller Select, Hopsak 2, Intent, Iota, Jaw, Keyless Entry, Keyn Chair Group by Herman Miller, Latitude, Lino, Locale, Logic Mini, Logic Power Access Solutions, Live OS, Loop, Lyris, Lyris 2, Made-to-Measure Storage, Metaform Portfolio, Mora, Motia, Multiscrim, Nelson, Pari, Pixelated Support, Plex, PostureFit SL, Prospect, Q, Renew, Sense, Soft Pad, Stackable, Stackable Storage, Striad, Swoop, Tone, TriFlex, Twist, Ubi, Verus and Wireframe are among the trademarks of Herman Miller, Inc., and its owned subsidiaries.

SM Herman Miller Options is among the service marks of Herman Miller, Inc.

Alexander Girard® is a registered trademark of The Alexander Girard Estate.

Chemsurf® is a registered trademark of Wilsonart International.

Corian® is a registered trademark of E. I. du Pont de Nemours and Company Corporation.

Crypton® is a registered trademark of Crypton, Inc.

DACRON® is a registered trademark of INVISTA S.a r.l.

Edelman® Leather is a registered trademark of Edelman Leather, Inc.

FENIX NTM® is a registered trademark of Arpa Industriale S.p.A.

FLEXNET™ is a trademark of Milliken & Company.

Floor Saver Glide® is a registered trademark of Carpin Manufacturing, Inc.

Geiger® is a registered trademark, and Bumper™, Saiba™, and Ward Bennett™ are trademarks, of Geiger International.

Goetz™ is a trademark of Mark W. Goetz.

Hang-It-All® is a registered trademark of Lucia Eames Demetrios, d.b.a. Eames Office.

Holophane® is a registered trademark of Holophane.

Ingeo™ is a trademark of Cargill Dow LLC.

iPad® is a registered trademark of Apple, Inc.

LifeSize® is a registered trademark of LifeSize Communications, Inc.

Magis®, Bombo®, and Me Too® are registered trademarks of Magis S.p.A.

Microsoft® and Natural® Keyboard are registered trademarks of Microsoft Corporation.

Noguchi® and the Noguchi table configuration (trade dress) are registered trademarks, and Rudder Table™ is a trademark, of The Isamu Noguchi Foundation and Garden Museum.

Place Textiles® is a registered trademark of Place Textiles.

SuperSeat™ is a trademark of Dahti Seating, a division of ITW.